

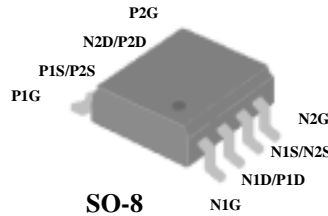

- ▼ Simple Drive Requirement
- ▼ Low On-resistance
- ▼ Full Bridge Application on LCD Monitor Inverter



N-CH	BV_{DSS}	35V
	$R_{DS(ON)}$	48m Ω
	I_D	4.3A
P-CH	BV_{DSS}	-35V
	$R_{DS(ON)}$	72m Ω
	I_D	-3.6A

Description

The Advanced Power MOSFETs from APEC provide the designer with the best combination of fast switching, ruggedized device design, low on-resistance and cost-effectiveness.

The SO-8 package is universally preferred for all commercial-industrial surface mount applications and suited for low voltage applications such as DC/DC converters.

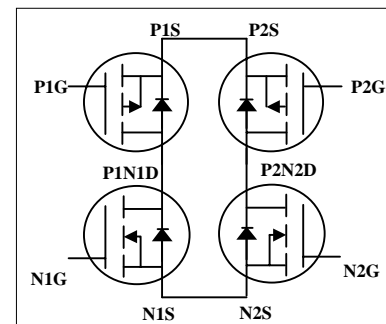

Absolute Maximum Ratings

Symbol	Parameter	Rating		Units
		N-channel	P-channel	
V_{DS}	Drain-Source Voltage	35	-35	V
V_{GS}	Gate-Source Voltage	± 20	± 20	V
$I_D @ T_A=25^\circ C$	Continuous Drain Current ³	4.3	-3.6	A
$I_D @ T_A=70^\circ C$	Continuous Drain Current ³	3.4	-2.8	A
I_{DM}	Pulsed Drain Current ¹	20	-20	A
$P_D @ T_A=25^\circ C$	Total Power Dissipation	1.38		W
	Linear Derating Factor	0.01		W/ $^\circ C$
T_{STG}	Storage Temperature Range	-55 to 150		$^\circ C$
T_J	Operating Junction Temperature Range	-55 to 150		$^\circ C$

Thermal Data

Symbol	Parameter	Value	Unit
Rthj-a	Thermal Resistance Junction-ambient ³	Max. 90	$^\circ C/W$



AP9934GM

N-CH Electrical Characteristics @T_j=25°C(unless otherwise specified)

Symbol	Parameter	Test Conditions	Min.	Typ.	Max.	Units	
BV _{DSS}	Drain-Source Breakdown Voltage	V _{GS} =0V, I _D =250uA	35	-	-	V	
ΔBV _{DSS} /ΔT _j	Breakdown Voltage Temperature Coefficient	Reference to 25°C, I _D =1mA	-	0.03	-	V/°C	
R _{DS(ON)}	Static Drain-Source On-Resistance ²	V _{GS} =10V, I _D =4A	-	-	48	mΩ	
		V _{GS} =4.5V, I _D =3A	-	-	70	mΩ	
V _{GS(th)}	Gate Threshold Voltage	V _{DS} =V _{GS} , I _D =250uA	1	-	3	V	
g _{fs}	Forward Transconductance	V _{DS} =10V, I _D =4A	-	8	-	S	
I _{DSS}	Drain-Source Leakage Current (T _f =25°C)	V _{DS} =30V, V _{GS} =0V	-	-	1	uA	
	Drain-Source Leakage Current (T _f =70°C)	V _{DS} =24V, V _{GS} =0V	-	-	25	uA	
I _{GSS}	Gate-Source Leakage	V _{GS} =±20V	-	-	±100	nA	
Q _g	Total Gate Charge ²	I _D =4A	-	6	10	nC	
Q _{gs}	Gate-Source Charge		V _{DS} =28V	-	2	-	nC
Q _{gd}	Gate-Drain ("Miller") Charge		V _{GS} =4.5V	-	3	-	nC
t _{d(on)}	Turn-on Delay Time ²	V _{DS} =15V	-	6	-	ns	
t _r	Rise Time	I _D =1A	-	5	-	ns	
t _{d(off)}	Turn-off Delay Time	R _G =3.3Ω, V _{GS} =10V	-	14	-	ns	
t _f	Fall Time	R _D =15Ω	-	4	-	ns	
C _{iss}	Input Capacitance	V _{GS} =0V	-	490	780	pF	
C _{oss}	Output Capacitance	V _{DS} =25V	-	130	-	pF	
C _{rss}	Reverse Transfer Capacitance	f=1.0MHz	-	55	-	pF	

Source-Drain Diode

Symbol	Parameter	Test Conditions	Min.	Typ.	Max.	Units
V _{SD}	Forward On Voltage ²	I _S =1.2A, V _{GS} =0V	-	-	1.2	V
t _{rr}	Reverse Recovery Time	I _S =4A, V _{GS} =0V	-	18	-	ns
Q _{rr}	Reverse Recovery Charge		dI/dt=100A/μs	-	11	-



P-CH Electrical Characteristics @T_j=25°C(unless otherwise specified)

Symbol	Parameter	Test Conditions	Min.	Typ.	Max.	Units
BV _{DSS}	Drain-Source Breakdown Voltage	V _{GS} =0V, I _D =-250uA	-35	-	-	V
ΔBV _{DSS} /ΔT _j	Breakdown Voltage Temperature Coefficient	Reference to 25°C, I _D =-1mA	-	-0.02	-	V/°C
R _{DS(ON)}	Static Drain-Source On-Resistance ²	V _{GS} =-10V, I _D =-3A	-	-	72	mΩ
		V _{GS} =-4.5V, I _D =-2A	-	-	100	mΩ
V _{GS(th)}	Gate Threshold Voltage	V _{DS} =V _{GS} , I _D =-250uA	-1	-	-3	V
g _{fs}	Forward Transconductance	V _{DS} =-10V, I _D =-3A	-	6	-	S
I _{DSS}	Drain-Source Leakage Current (T=25°C)	V _{DS} =-30V, V _{GS} =0V	-	-	-1	uA
	Drain-Source Leakage Current (T=70°C)	V _{DS} =-24V, V _{GS} =0V	-	-	-25	uA
I _{GSS}	Gate-Source Leakage	V _{GS} =±20V	-	-	±100	nA
Q _g	Total Gate Charge ²	I _D =-3A	-	6	10	nC
Q _{gs}	Gate-Source Charge	V _{DS} =-28V	-	1	-	nC
Q _{gd}	Gate-Drain ("Miller") Charge	V _{GS} =-4.5V	-	3	-	nC
t _{d(on)}	Turn-on Delay Time ²	V _{DS} =-15V	-	7	-	ns
t _r	Rise Time	I _D =-1A	-	5	-	ns
t _{d(off)}	Turn-off Delay Time	R _G =3.3Ω, V _{GS} =-10V	-	19	-	ns
t _f	Fall Time	R _D =15Ω	-	4	-	ns
C _{iss}	Input Capacitance	V _{GS} =0V	-	420	1100	pF
C _{oss}	Output Capacitance	V _{DS} =-25V	-	140	-	pF
C _{rss}	Reverse Transfer Capacitance	f=1.0MHz	-	65	-	pF

Source-Drain Diode

Symbol	Parameter	Test Conditions	Min.	Typ.	Max.	Units
V _{SD}	Forward On Voltage ²	I _S =-1.2A, V _{GS} =0V	-	-	-1.2	V
t _{rr}	Reverse Recovery Time	I _S =-3A, V _{GS} =0V	-	20	-	ns
Q _{rr}	Reverse Recovery Charge	di/dt=-100A/μs	-	16	-	nC

Notes:

- 1.Pulse width limited by Max. junction temperature.
- 2.Pulse width ≤300us , duty cycle ≤2%.
- 3.Surface mounted on 1 in² copper pad of FR4 board , t ≤10sec ; 186 °C/W when mounted on Min. copper pad.

AP9934GM



N-Channel

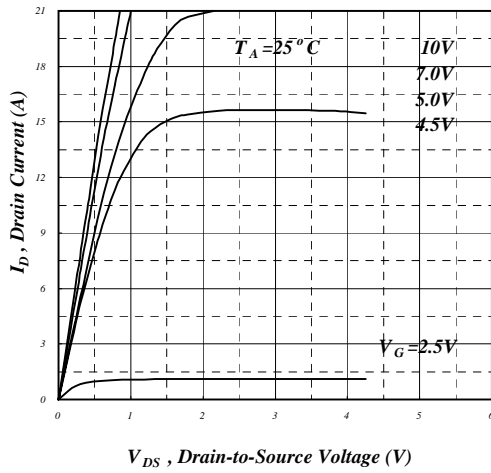

Fig 1. Typical Output Characteristics

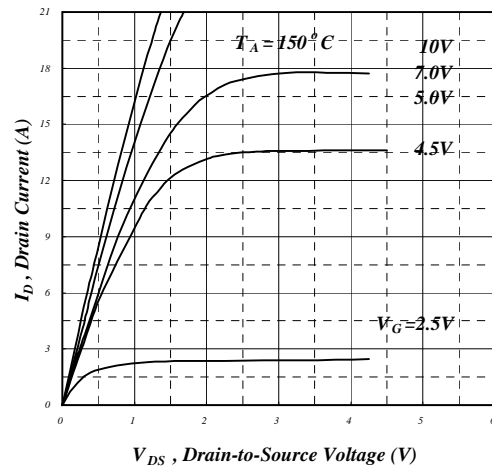

Fig 2. Typical Output Characteristics

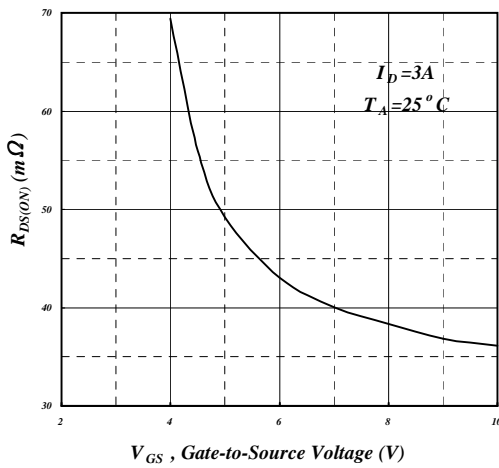

Fig 3. On-Resistance v.s. Gate Voltage

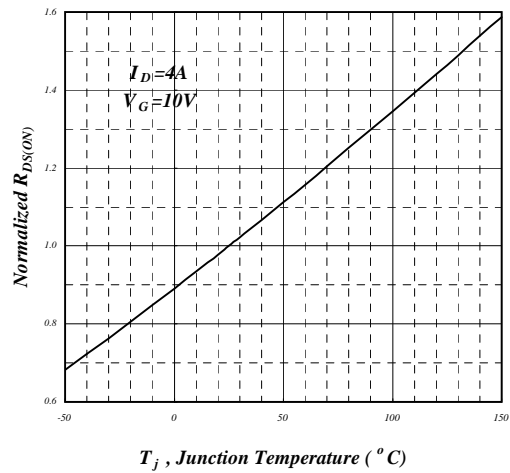

Fig 4. Normalized On-Resistance v.s. Junction Temperature

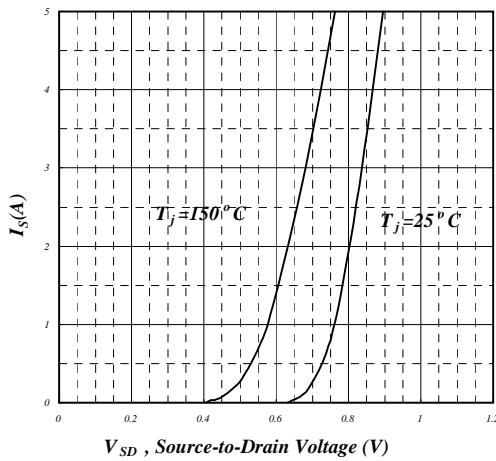

Fig 5. Forward Characteristic of Reverse Diode

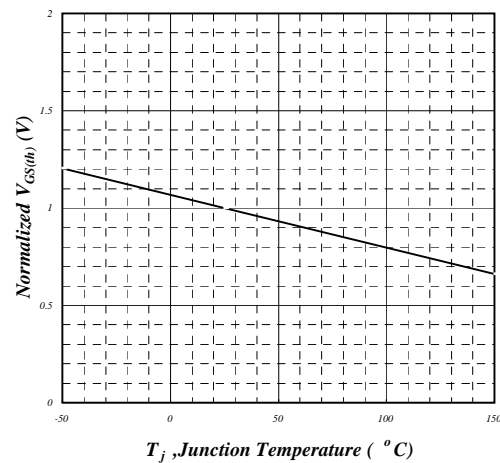

Fig 6. Gate Threshold Voltage v.s. Junction Temperature



N-Channel

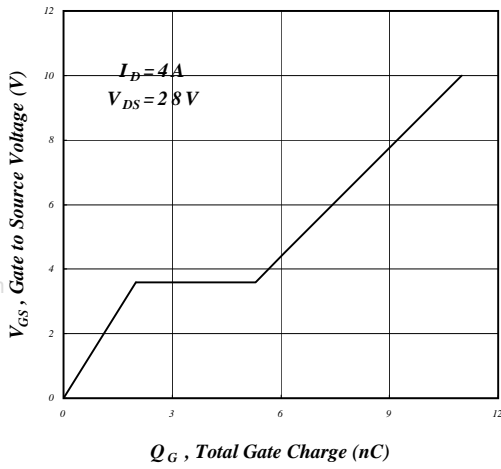

Fig 7. Gate Charge Characteristics

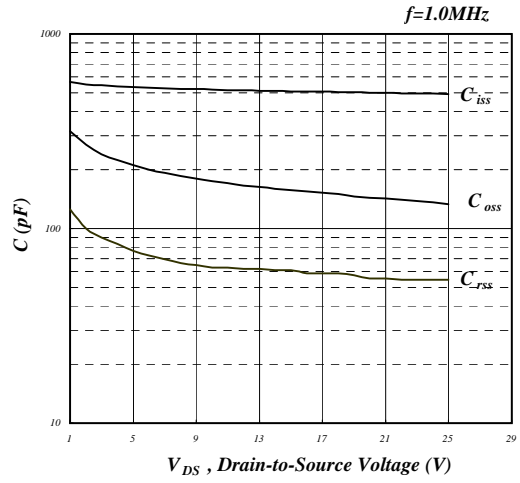

Fig 8. Typical Capacitance Characteristics

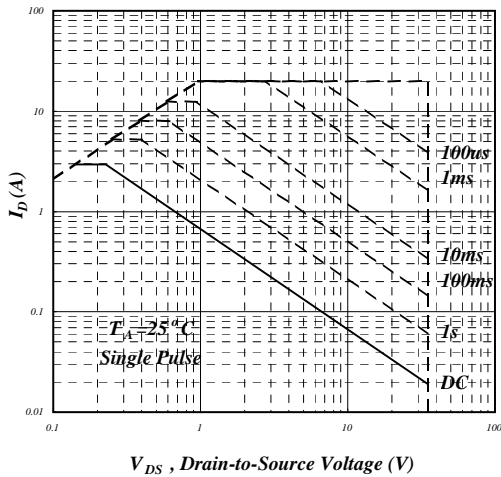

Fig 9. Maximum Safe Operating Area

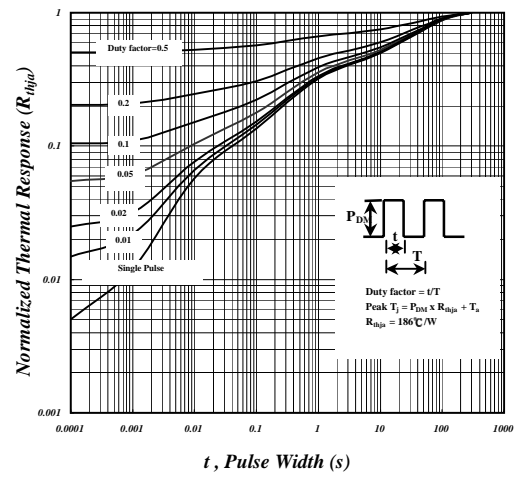

Fig 10. Effective Transient Thermal Impedance

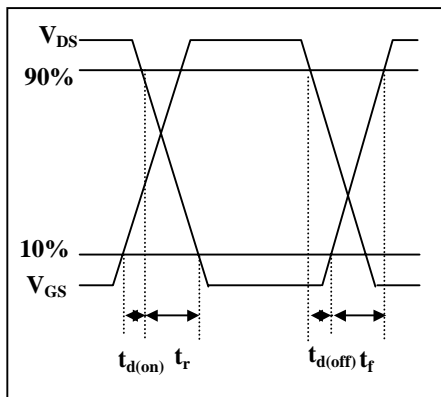

Fig 11. Switching Time Waveform

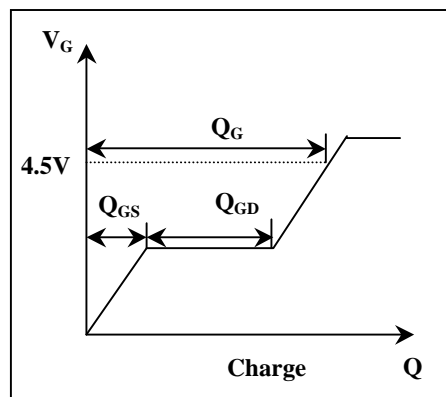

Fig 12. Gate Charge Waveform



AP9934GM

P-Channel

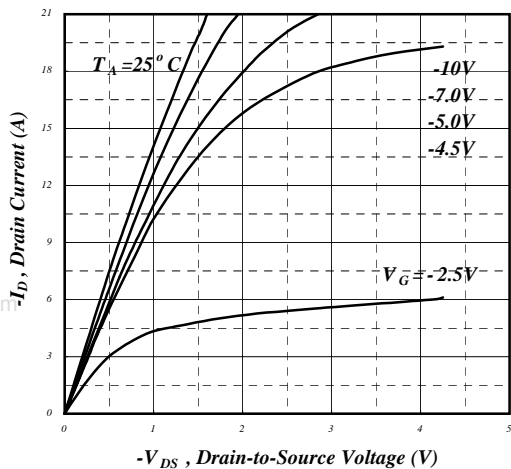

Fig 1. Typical Output Characteristics

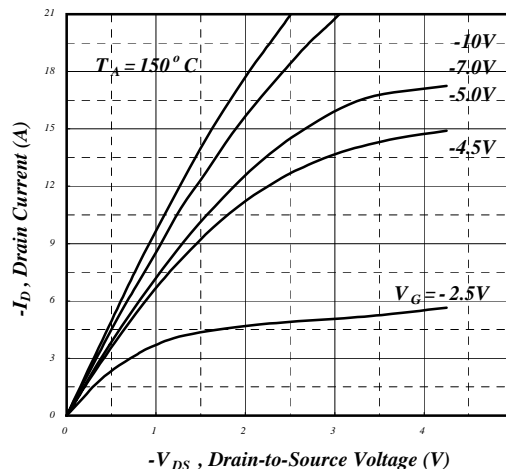

Fig 2. Typical Output Characteristics

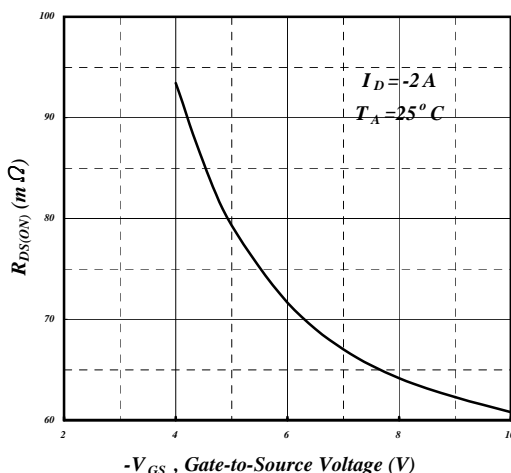

Fig 3. On-Resistance v.s. Gate Voltage

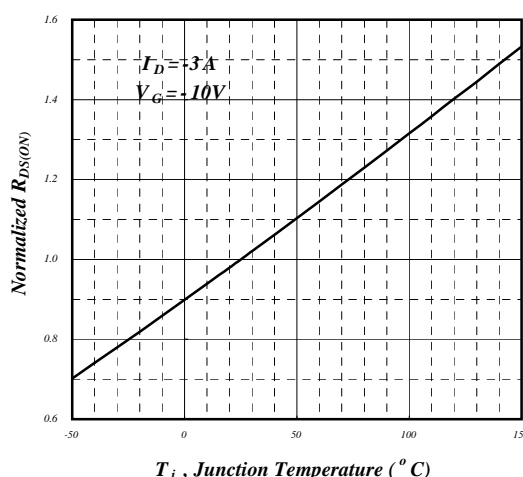

Fig 4. Normalized On-Resistance v.s. Junction Temperature

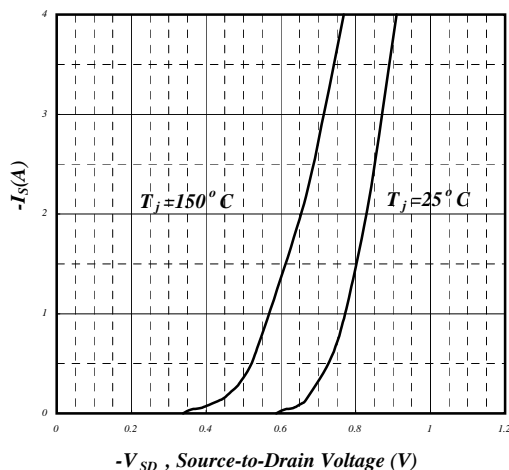

Fig 5. Forward Characteristic of Reverse Diode

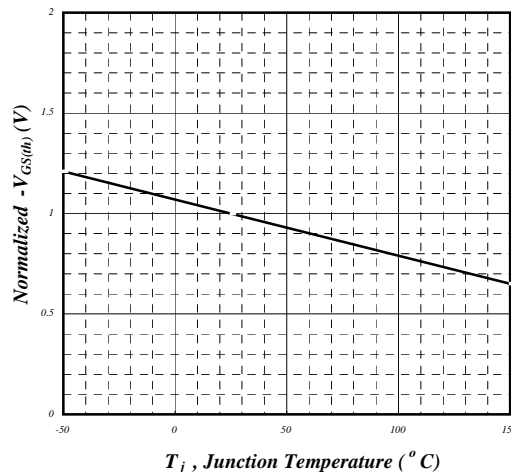

Fig 6. Gate Threshold Voltage v.s. Junction Temperature



P-Channel

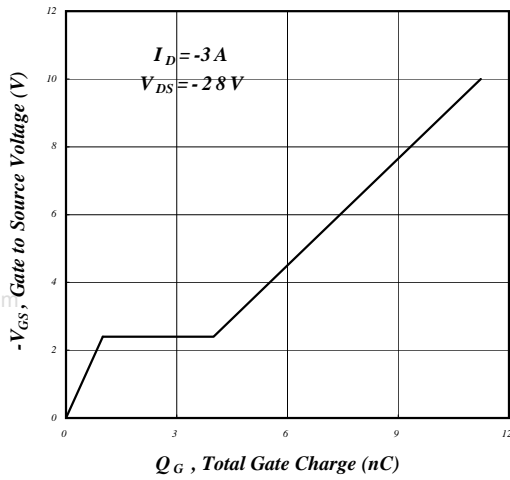

Fig 7. Gate Charge Characteristics

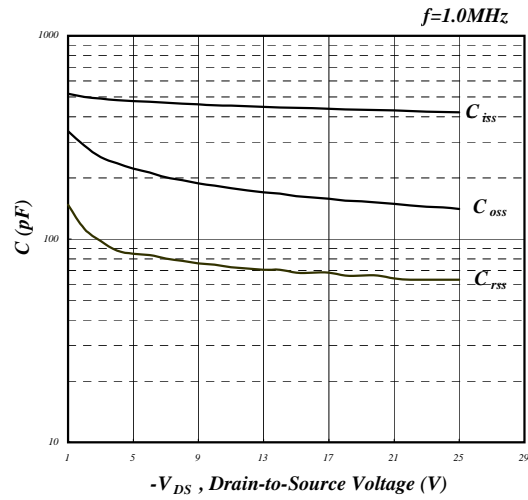

Fig 8. Typical Capacitance Characteristics

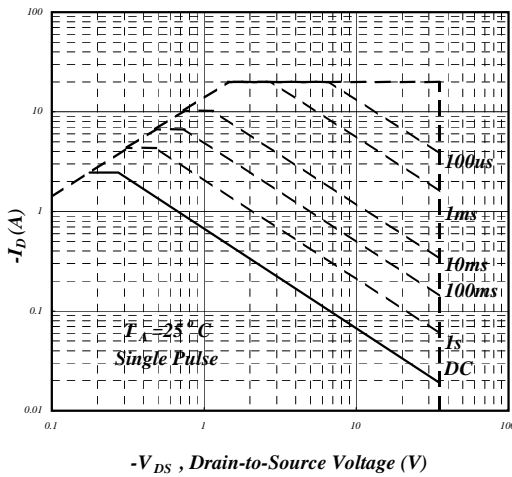

Fig 9. Maximum Safe Operating Area

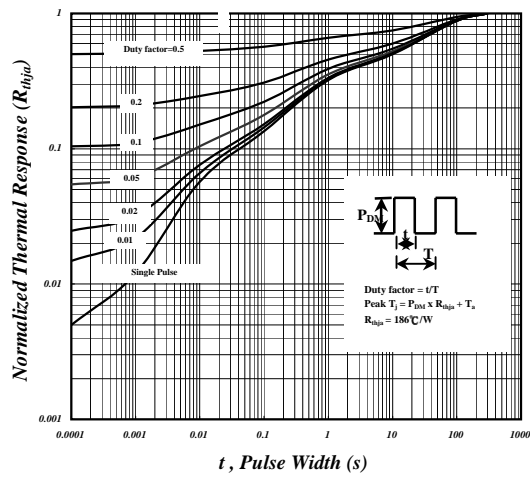

Fig 10. Effective Transient Thermal Impedance

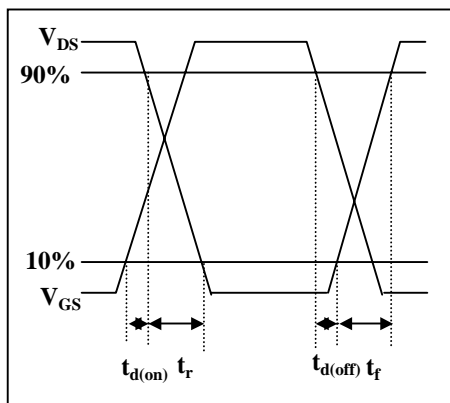

Fig 11. Switching Time Waveform

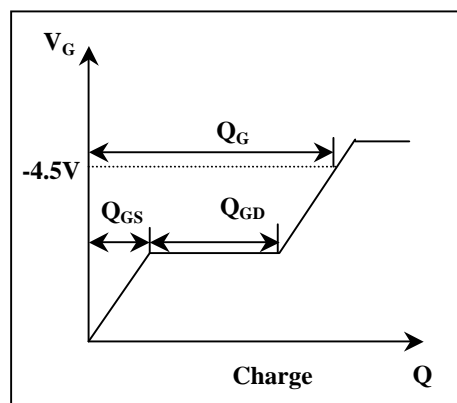

Fig 12. Gate Charge Waveform