

# High-output dual power amplifier

## BA5417

The BA5417 is a 6 to 15V-compatible dual power amplifier developed for use radio cassette players. It is equipped with standby switching functions for excellent total harmonic distortion and other basic characteristics.

### ●Applications

Radio cassette / Mini compo players

### ●Features

- 1) High output.  
 $P_{OUT} = 2.8W$  ( $V_{CC} = 9V$ ,  $R_L = 3\Omega$ , THD = 10%)  
 $P_{OUT} = 5.0W$  ( $V_{CC} = 12V$ ,  $R_L = 3\Omega$ , THD = 10%)
- 2) Excellent audio quality  
 THD = 0.1% ( $f = 1kHz$ ,  $P_o = 0.5W$ )  
 $V_{NO} = 0.3mV_{rms}$  ( $R_g = 10k\Omega$ )  
 $RR = 55dB$  ( $f_{RR} = 100Hz$ )
- 3) Wide supply voltage operating range  
 ( $V_{CC} = 6.0V$  to  $15.0V$ ).
- 4) Switching noise ("pop" noise) generated when the power is switched on and off is small.
- 5) Ripple mixing when motor starts has been prevented.
- 6) Built-in thermal shutdown circuit.
- 7) Built-in standby switch. Output is not influenced by the standby pin voltage.
- 8) Soft clipping.

### ●Absolute maximum ratings ( $T_a = 25^\circ C$ )

Parameter	Symbol	Limits	Unit
Power supply voltage	$V_{CC}$	20*1	V
Power dissipation	$P_d$	15*2	W
Operating temperature	$T_{opr}$	-20 ~ +75	$^\circ C$
Storage temperature	$T_{stg}$	-55 ~ +150	$^\circ C$

\*1 Must be within standby values.

\*2  $T_a = 75^\circ C$  (when using infinite heatsink)

### ●Recommended operating conditions ( $T_a = 25^\circ C$ )

Parameter	Symbol	Limits	Unit
Power supply voltage	$V_{CC}$	6.0 ~ 15.0	V

Audio ICs

●Block diagram

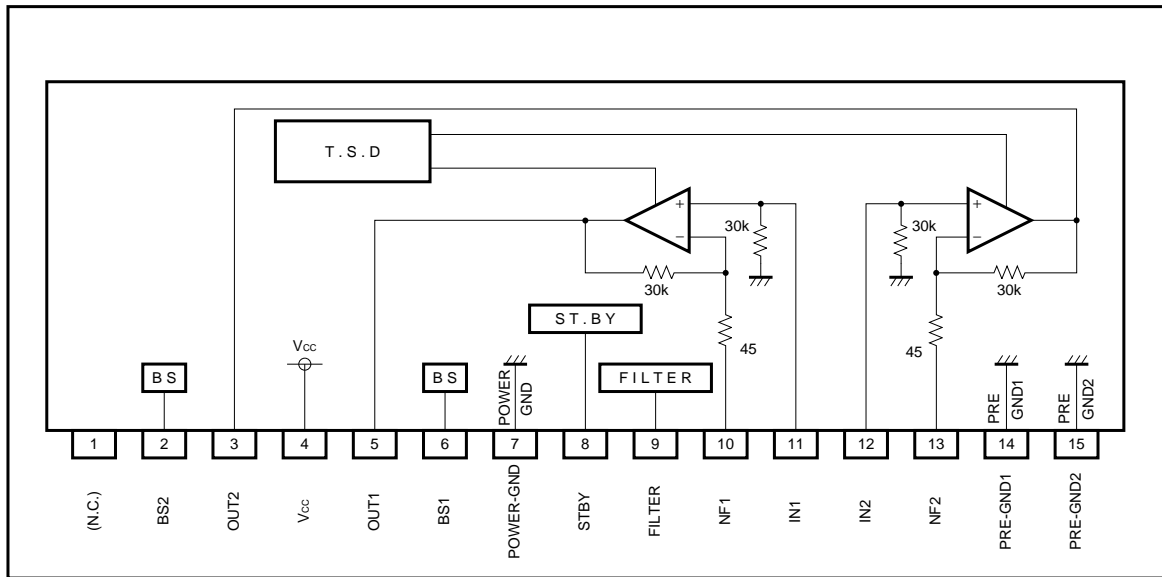

Audio ICs

●Electrical characteristics

(unless otherwise noted, Ta=25°C, Vcc=9.0V, RL=3Ω, RF=120Ω, Rg=600Ω, f=1kHz, OTL mode)

Parameter	Symbol	Min.	Typ.	Max.	Unit	Coniditions
Quiescent current	I <sub>o</sub>	–	22	45	mA	V <sub>IN</sub> =0Vrms
Rated output voltage 1	P <sub>OUT1</sub>	2.2	2.8	–	W	TDH=10%
Rated output voltage 2	P <sub>OUT2</sub>	4.0	5.0	–	W	TDH=10%, V <sub>CC</sub> =12V
Closed-loop voltage gain	G <sub>VC</sub>	43	45	47	dB	–
Output noise voltage	V <sub>NO</sub>	–	0.3	1.0	mVrms	R <sub>g</sub> =10kΩ, DIN AUDIO
Total harmonic distortion	THD	–	0.1	1.0	%	P <sub>OUT</sub> =0.5W
Ripple rejection	RR	42	55	–	dB	f <sub>RR</sub> =100Hz, V <sub>RR</sub> =-10dBm
Crosstalk	CT	48	65	–	dB	V <sub>o</sub> =0dBm
Circuit current (with standby switch off)	I <sub>OFF</sub>	–	0	20	μA	–
Standby pin current when on	I <sub>SIN</sub>	–	0.15	0.4	mA	V <sub>STBY</sub> =V <sub>CC</sub>
Standby pin control voltage	Activated	V <sub>STH</sub>	3.5	–	–	–
	Not activated	V <sub>STL</sub>	–	–	1.2	–

●Measurement circuit

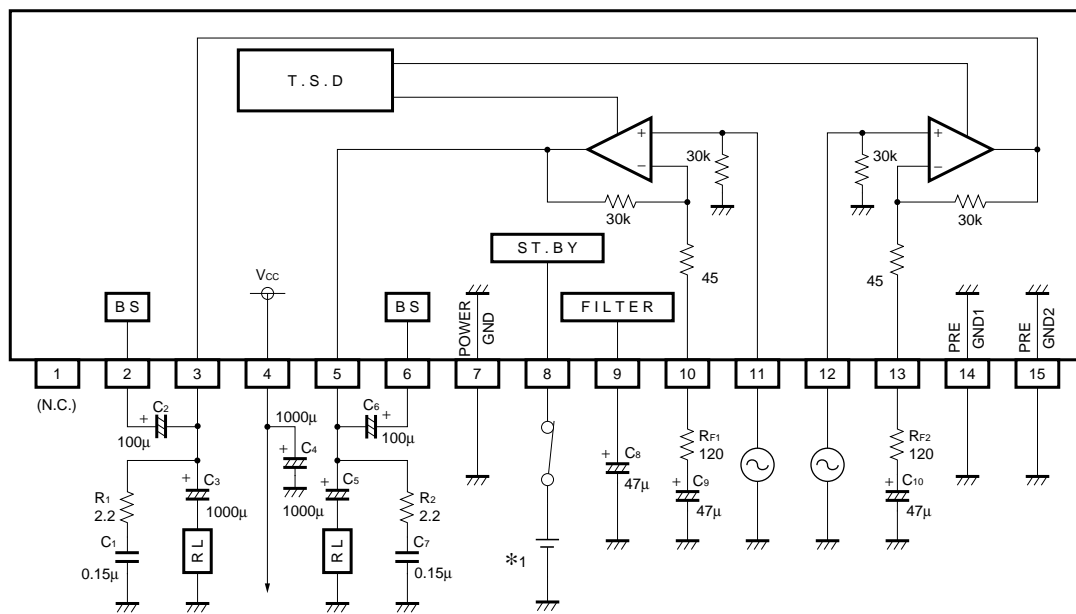

\*1 V<sub>STBY</sub>=3.5V ~ V<sub>CC</sub>

Fig.1

Audio ICs

●Application example

OTL mode circuit

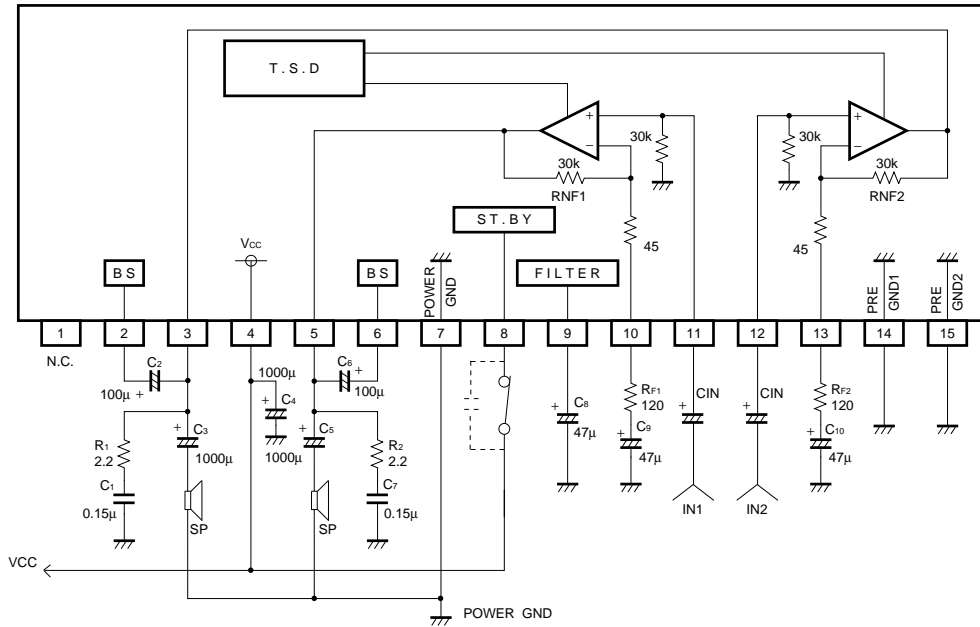
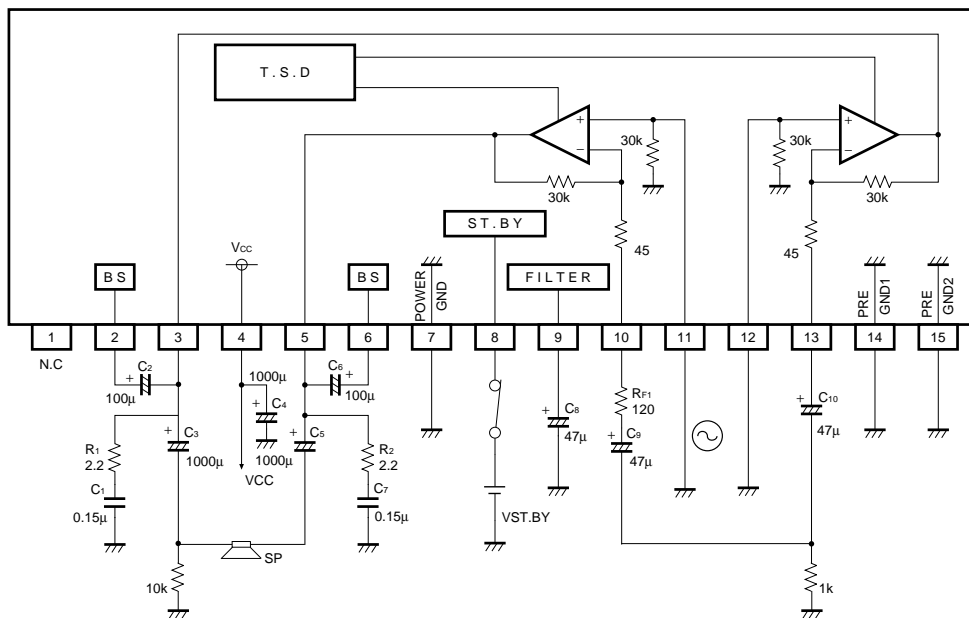

Fig.2

BTL mode circuit



Note : 3pin,5pin need coupling capacitors (C3,C5 100µF) for DC offset voltage.

Fig.3

Audio ICs

●Electrical characteristics

OTL mode

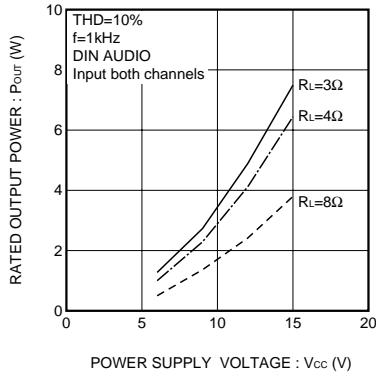

POWER SUPPLY VOLTAGE :  $V_{CC}$  (V)  
Fig.4 Rated output power vs. Power supply voltage

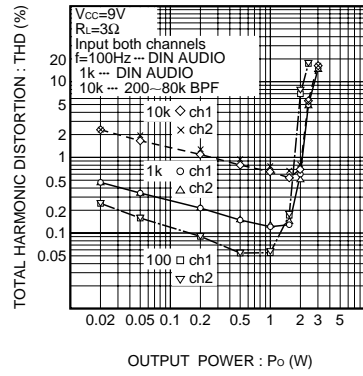

OUTPUT POWER :  $P_o$  (W)  
Fig.5 Total harmonic distortion vs. Output power

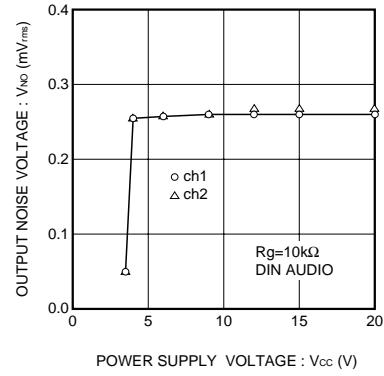

POWER SUPPLY VOLTAGE :  $V_{CC}$  (V)  
Fig.6 Output noise voltage vs. Power supply voltage

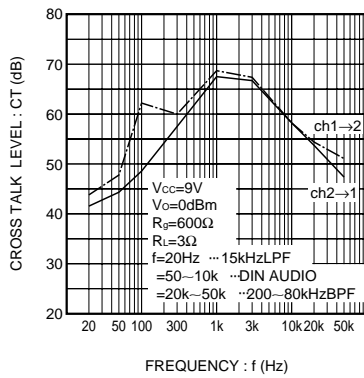

FREQUENCY :  $f$  (Hz)  
Fig.7 Crosstalk vs. Frequency

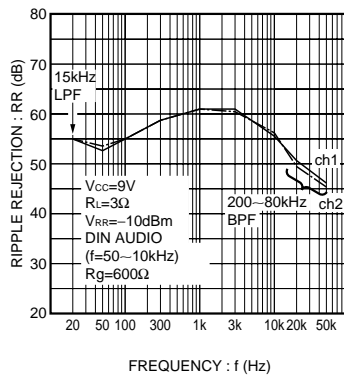

FREQUENCY :  $f$  (Hz)  
Fig.8 Ripple rejection vs. Frequency

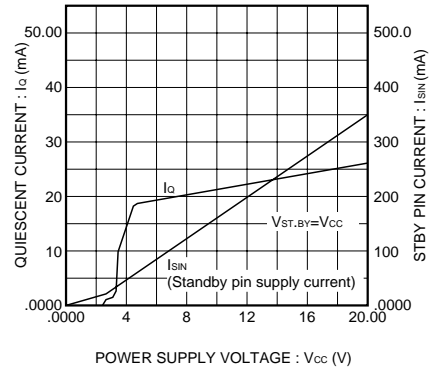

POWER SUPPLY VOLTAGE :  $V_{CC}$  (V)  
Fig.9 Quiescent standby pin supply current vs. Power supply voltage

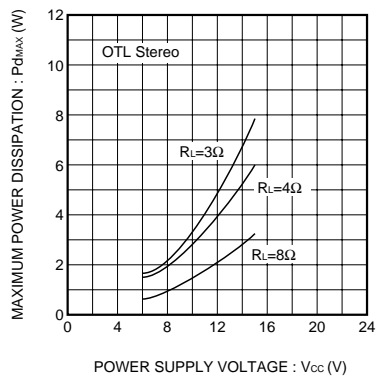

POWER SUPPLY VOLTAGE :  $V_{CC}$  (V)  
Fig.10 Maximum power dissipation vs. Power supply voltage

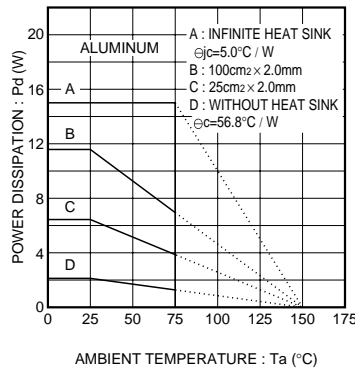

AMBIENT TEMPERATURE :  $T_a$  (°C)  
Fig.11 Thermal derating curve

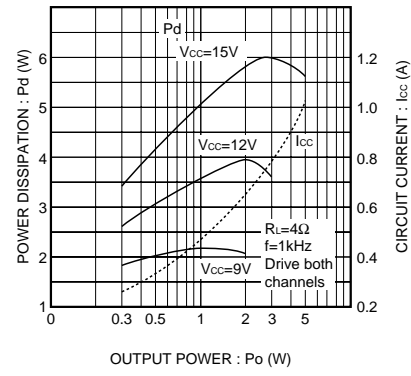

OUTPUT POWER :  $P_o$  (W)  
Fig.12 Power dissipation vs. Power supply voltage ( $R_L=4\Omega$ )

Audio ICs

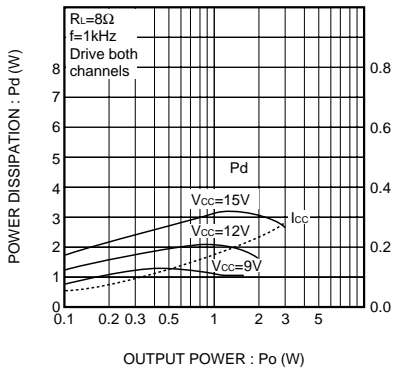

Fig.13 Power dissipation vs. Power supply voltage (RL=8Ω)

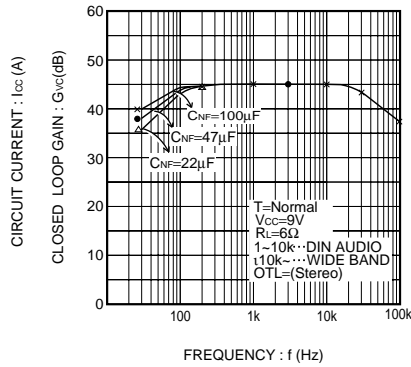

Fig.14 Closed loop gain vs. Frequency

BTL mode

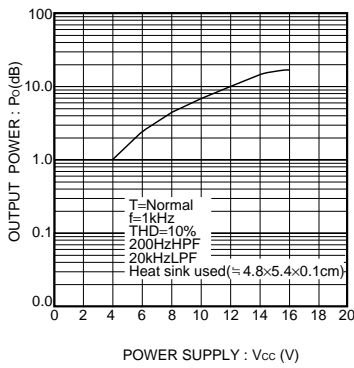

Fig.15 Rated output power vs. Power supply voltage

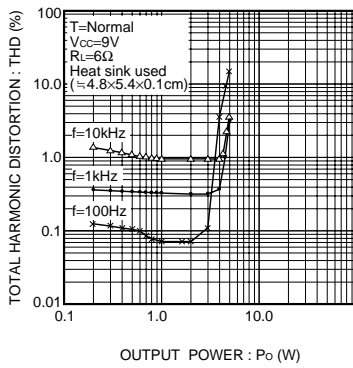

Fig.16 Total harmonic distortion vs. Output power

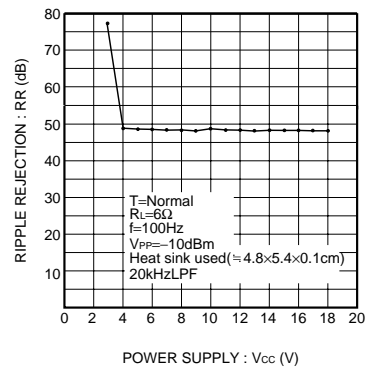

Fig.17 Ripple rejection vs. Power supply voltage

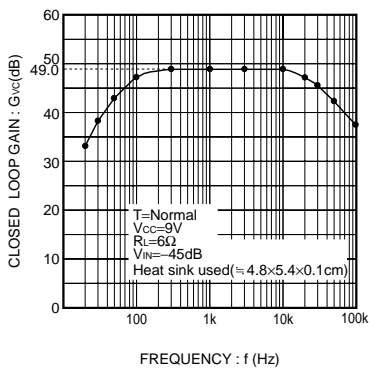

Fig.18 Closed loop gain vs. Frequency

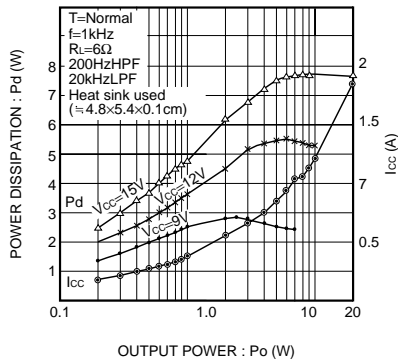

Fig.19 Power dissipation vs. Power supply voltage (RL=6Ω)

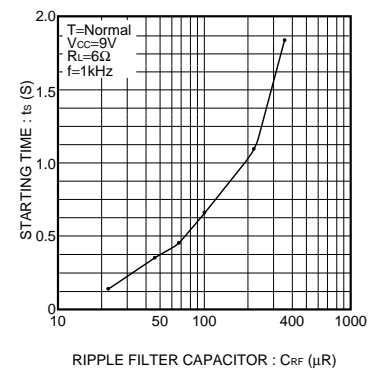
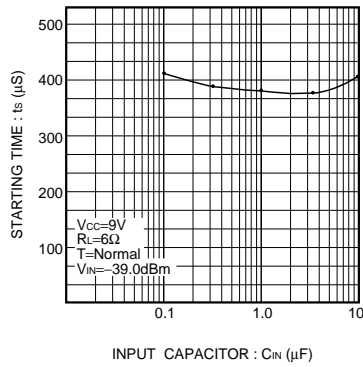

Fig.20 Starting time vs. Ripple filter capacitor

Audio ICs



INPUT CAPACITOR : CIN (μF)

Fig.21 Starting time vs. Input capacitor

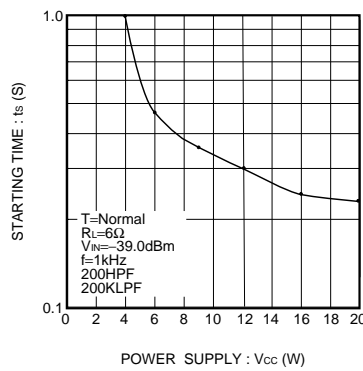

POWER SUPPLY : VCC (V)

Fig.22 Starting time vs. Power supply voltage

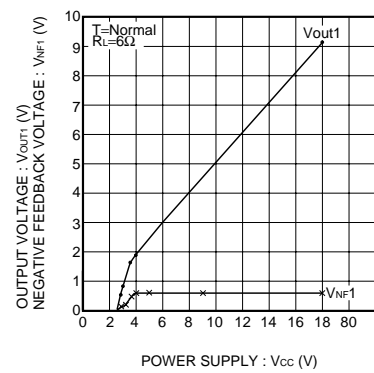

POWER SUPPLY : VCC (V)

Fig.23 Output voltage Negative feedback voltage vs. Power supply voltage

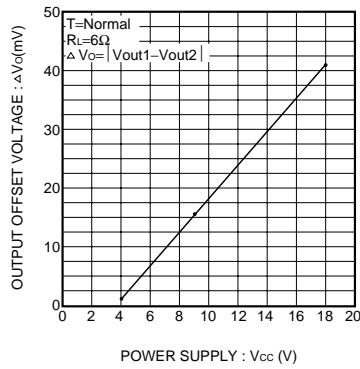

POWER SUPPLY : VCC (V)

Fig.24 Output offset voltage vs. Power supply voltage

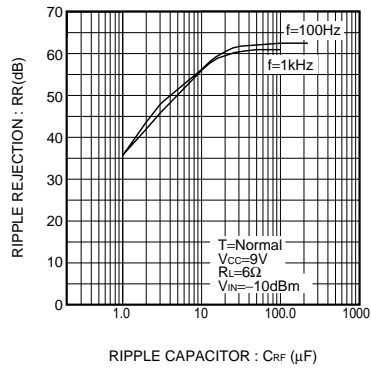

RIPPLE CAPACITOR : CREF (μF)

Fig.25 Ripple rejection vs. Ripple filter capacitor

●External dimensions (Units : mm)

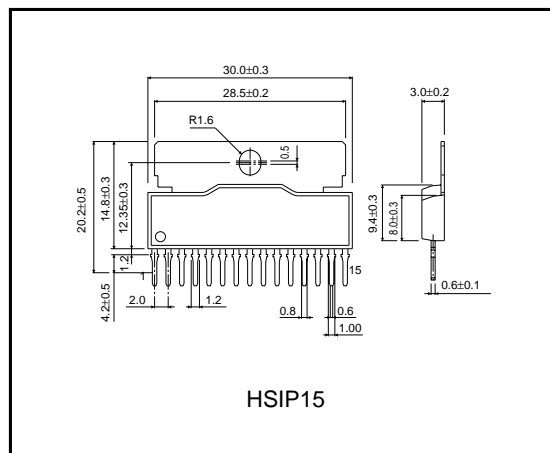

HSIP15

### Notes

- No technical content pages of this document may be reproduced in any form or transmitted by any means without prior permission of ROHM CO.,LTD.
- The contents described herein are subject to change without notice. The specifications for the product described in this document are for reference only. Upon actual use, therefore, please request that specifications to be separately delivered.
- Application circuit diagrams and circuit constants contained herein are shown as examples of standard use and operation. Please pay careful attention to the peripheral conditions when designing circuits and deciding upon circuit constants in the set.
- Any data, including, but not limited to application circuit diagrams information, described herein are intended only as illustrations of such devices and not as the specifications for such devices. ROHM CO.,LTD. disclaims any warranty that any use of such devices shall be free from infringement of any third party's intellectual property rights or other proprietary rights, and further, assumes no liability of whatsoever nature in the event of any such infringement, or arising from or connected with or related to the use of such devices.
- Upon the sale of any such devices, other than for buyer's right to use such devices itself, resell or otherwise dispose of the same, no express or implied right or license to practice or commercially exploit any intellectual property rights or other proprietary rights owned or controlled by
- ROHM CO., LTD. is granted to any such buyer.
- Products listed in this document use silicon as a basic material.  
Products listed in this document are no antiradiation design.

The products listed in this document are designed to be used with ordinary electronic equipment or devices (such as audio visual equipment, office-automation equipment, communications devices, electrical appliances and electronic toys).

Should you intend to use these products with equipment or devices which require an extremely high level of reliability and the malfunction of which would directly endanger human life (such as medical instruments, transportation equipment, aerospace machinery, nuclear-reactor controllers, fuel controllers and other safety devices), please be sure to consult with our sales representative in advance.

#### About Export Control Order in Japan

Products described herein are the objects of controlled goods in Annex 1 (Item 16) of Export Trade Control Order in Japan.

In case of export from Japan, please confirm if it applies to "objective" criteria or an "informed" (by MITI clause) on the basis of "catch all controls for Non-Proliferation of Weapons of Mass Destruction.