

S P S

The SPS product family is specially designed for an off-line SMPS with minimal external components. The SPS consist of high voltage power SenseFET and current mode PWM IC.

Included PWM controller features integrated fixed frequency oscillator, under voltage lock-out, leading edge blanking, optimized gate turn-on/turn-off driver, thermal shutdown protection, over voltage protection, and temperature compensated precision current sources for loop compensation and fault protection circuitry. Compared to discrete MOSFET and PWM controller or RCC solution, a SPS can reduce total component count, design size, weight and at the same time increase efficiency, productivity, and system reliability.

It has a basic platform well suited for cost-effective design in either a flyback converter or a forward converter.

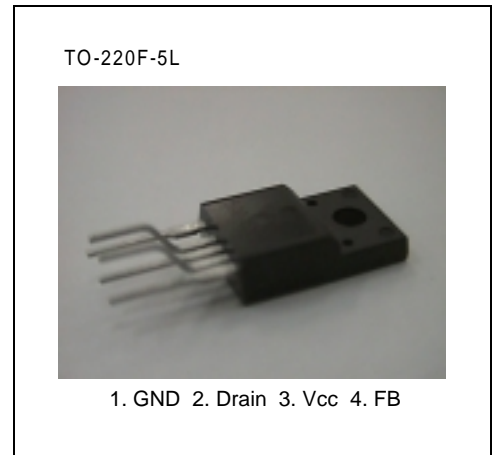

FEATURES

- Precision fixed operating frequency (70kHz)
- Low start-up current (Typ. 100mA)
- Pulse by pulse current limiting
- Over current protection
- Over voltage protection (Min. 25V)
- Internal thermal shutdown function
- Under voltage lockout
- Internal high voltage sense FET
- Auto-restart mode

ORDERING INFORMATION

Device	Package	Topr (°C)
KA5M0765RC	TO-220F-5L	-25°C to +85°C

BLOCK DIAGRAM

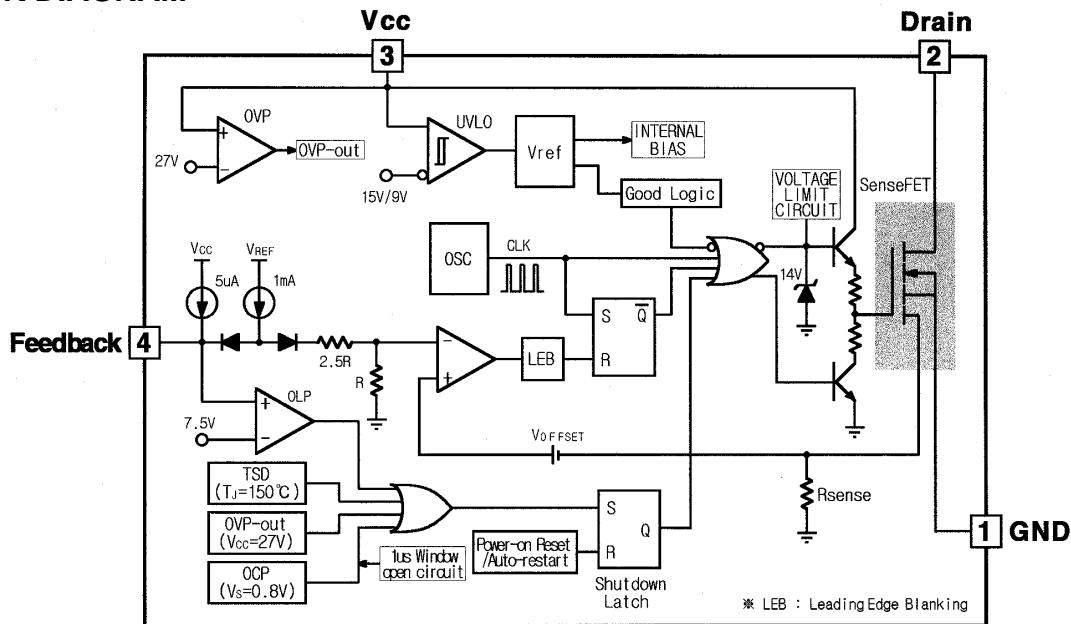

ABSOLUTE MAXIMUM RATINGS

Characteristic	Symbol	Value	Unit
Drain-source (GND) voltage ⁽¹⁾	V _{DSS}	650	V
Drain-Gate voltage (R _{GS} =1MΩ)	V _{DGR}	650	V
Gate-source (GND) voltage	V _{GS}	±30	V
Drain current pulsed ⁽²⁾	I _{DM}	28.0	A _{DC}
Single pulsed avalanche energy ⁽³⁾	E _{AS}	570	mJ
Avalanche current ⁽⁴⁾	I _{AS}	20	A
Continuous drain current (T _C =25°C)	I _D	7.0	A _{DC}
Continuous drain current (T _C =100°C)	I _D	5.6	A _{DC}
Supply voltage	V _{CC}	30	V
Analog input voltage range	V _{FB}	-0.3 to V _{SD}	V
Total power dissipation	P _D (wt H/S)	140	W
	Derating	1.11	W/°C
Operating temperature	T _{OPR}	-25 to +85	°C
Storage temperature	T _{STG}	-55 to +150	°C

NOTES:

1. T_j=25°C to 150°C
2. Repetitive rating: Pulse width limited by maximum junction temperature
3. L=24mH, starting T_j=25°C
4. L=13uH, starting T_j=25°C

ELECTRICAL CHARACTERISTICS (SFET part)

(Ta=25°C unless otherwise specified)

Characteristic	Symbol	Test condition	Min.	Typ.	Max.	Unit
Drain-source breakdown voltage	BV_{DSS}	$V_{GS}=0V, I_D=50\mu A$	650	–	–	V
Zero gate voltage drain current	I_{DSS}	$V_{DS}=\text{Max.}, \text{Rating}, V_{GS}=0V$	–	–	50	μA
		$V_{DS}=0.8\text{Max.}, \text{Rating}, V_{GS}=0V, T_C=125^\circ C$	–	–	200	μA
Static drain-source on resistance ^(note)	$R_{DS(ON)}$	$V_{GS}=10V, I_D=0.5A$	–	1.25	1.6	Ω
Forward transconductance ^(note)	gfs	$V_{DS}=50V, I_D=0.5A$	3.0	–	–	S
Input capacitance	C_{iss}	$V_{GS}=0V, V_{DS}=25V, f=1\text{MHz}$	–	1600	–	pF
Output capacitance	C_{oss}		–	310	–	
Reverse transfer capacitance	C_{rss}		–	120	–	
Turn on delay time	td(on)	$V_{DD}=0.5BV_{DSS}, I_D=1.0A$ (MOSFET switching time are essentially independent of operating temperature)	–	25	–	nS
Rise time	tr		–	55	–	
Turn off delay time	td(off)		–	80	–	
Fall time	tf		–	50	–	
Total gate charge (gate-source+gate-drain)	Qg	$V_{GS}=10V, I_D=1.0A, V_{DS}=0.5BV_{DSS}$ (MOSFET switching time are essentially independent of operating temperature)	–	–	72	nC
Gate-source charge	Qgs		–	9.3	–	
Gate-drain (Miller) charge	Qgd		–	29.3	–	

NOTE: Pulse test: Pulse width $\leq 300\mu S$, duty cycle $\leq 2\%$

ELECTRICAL CHARACTERISTICS (Control part)

(Ta=25°C unless otherwise specified)

Characteristic	Symbol	Test condition	Min.	Typ.	Max.	Unit
REFERENCE SECTION						
Output voltage ⁽¹⁾	Vref	Ta=25°C	4.80	5.00	5.20	V
Temperature Stability ⁽¹⁾⁽²⁾	Vref/ΔT	-25°C≤Ta≤+85°C	-	0.3	0.6	mV/°C
OSCILLATOR SECTION						
Initial accuracy	F _{OSC}	Ta=25°C	61	67	73	kHz
Frequency change with temperature ⁽²⁾	ΔF/ΔT	-25°C≤Ta≤+85°C	-	±5	±10	%
PWM SECTION						
Maximum duty cycle	Dmax	-	74	77	80	%
FEEDBACK SECTION						
Feedback source current	I _{FB}	Ta=25°C, 0V≤Vfb≤3V	0.7	0.9	1.1	mA
Shutdown delay current	I _{delay}	Ta=25°C, 5V≤Vfb≤V _{SD}	4	5	6	μA
OVER CURRENT PROTECTION SECTION						
Over current protection	I _L (max)	Max. inductor current	4.40	5.00	5.60	A
UVLO SECTION						
Start threshold voltage	V _{th} (H)	-	8.4	9	9.6	V
Minimum operating voltage	V _{th} (L)	After turn on	14	15	16	V
TOTAL STANDBY CURRENT SECTION						
Start current	I _{ST}	V _{CC} =14V	-	0.1	0.17	mA
Operating supply current (control part only)	I _{OPR}	V _{CC} ≤28	-	7	12	mA
SHUTDOWN SECTION						
Shutdown Feedback voltage	V _{SD}	Vfb≥6.5V	6.9	7.5	8.1	V
Thermal shutdown temperature (Tj) ⁽¹⁾	T _{SD}	-	140	160	-	°C
Over voltage protection	V _{OVP}	V _{CC} ≥24V	25	27	29	V

NOTES:

1. These parameters, although guaranteed, are not 100% tested in production
2. These parameters, although guaranteed, are tested in EDS (wafer test) process

TYPICAL PERFORMANCE CHARACTERISTICS (SFET part)

Fig 1. Output Characteristics

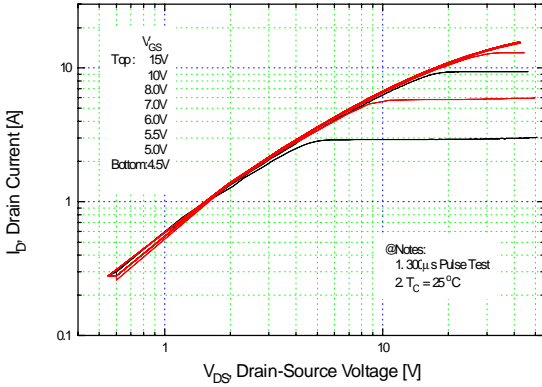

Fig. 2 Transfer Characteristics

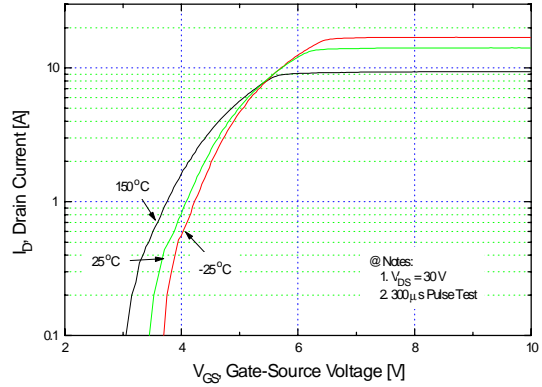

Fig. 3 On-Resistance vs. Drain Current

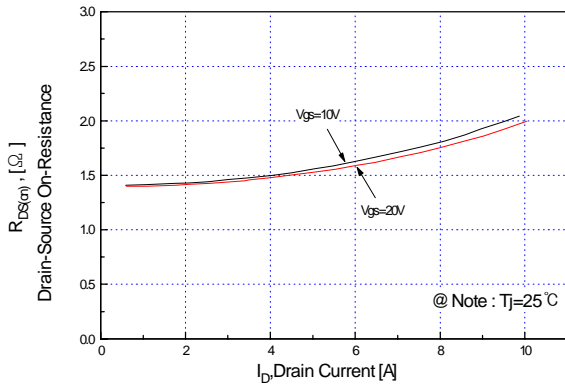

Fig. 4 Source-Drain Diode Forward Voltage

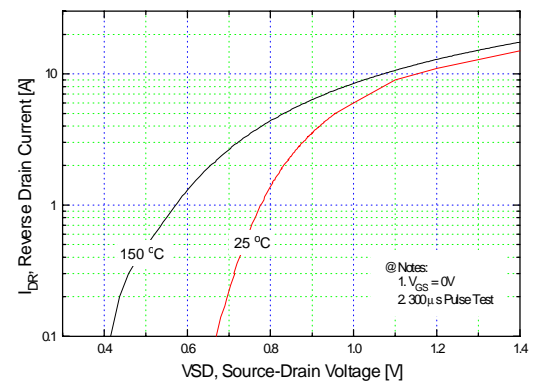

Fig.5 Capacitance vs. Drain-Source Voltage

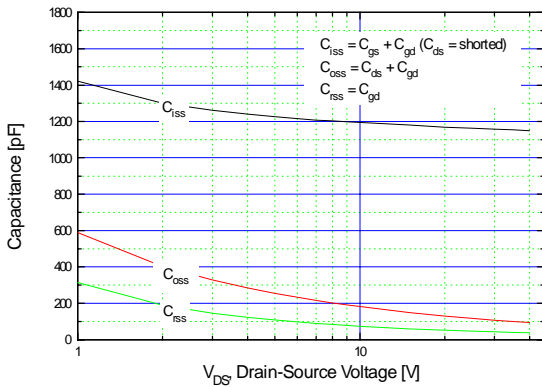
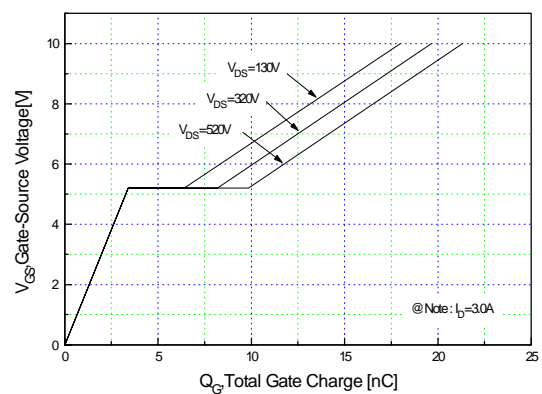

Fig. 6 Gate Charge vs. Gate-Source Voltage



TYPICAL PERFORMANCE CHARACTERISTICS (Continued)

Fig. 7 Breakdown Voltage vs. Temperature

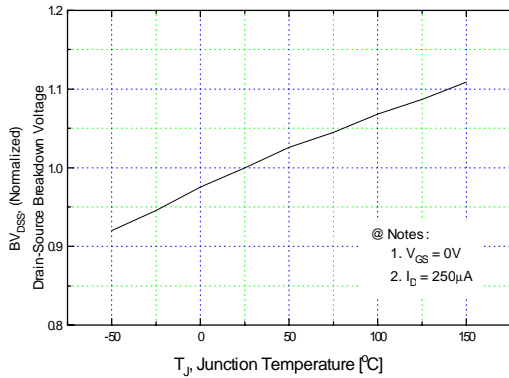

Fig. 8 On-Resistance vs. Temperature

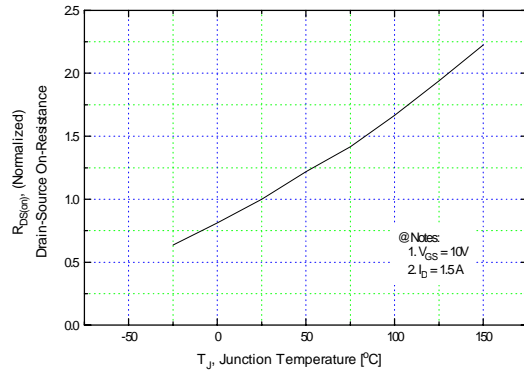

Fig. 9 Max. Safe Operating Area

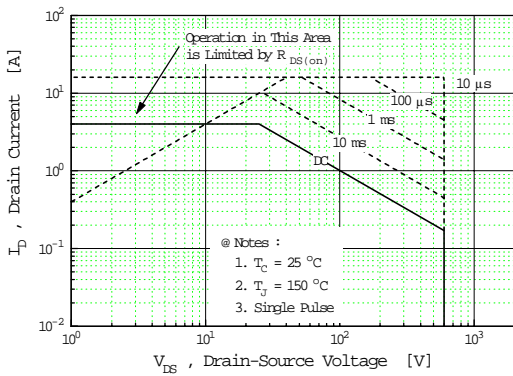

Fig. 10 Max. Drain Current vs. Case Temperature

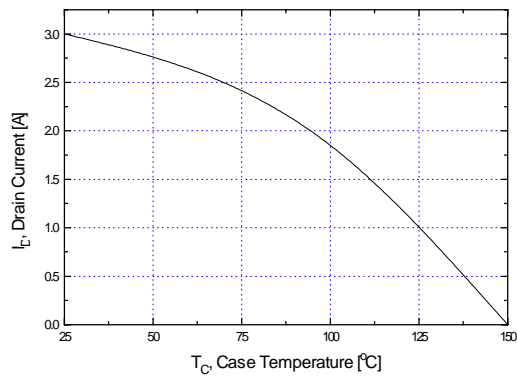
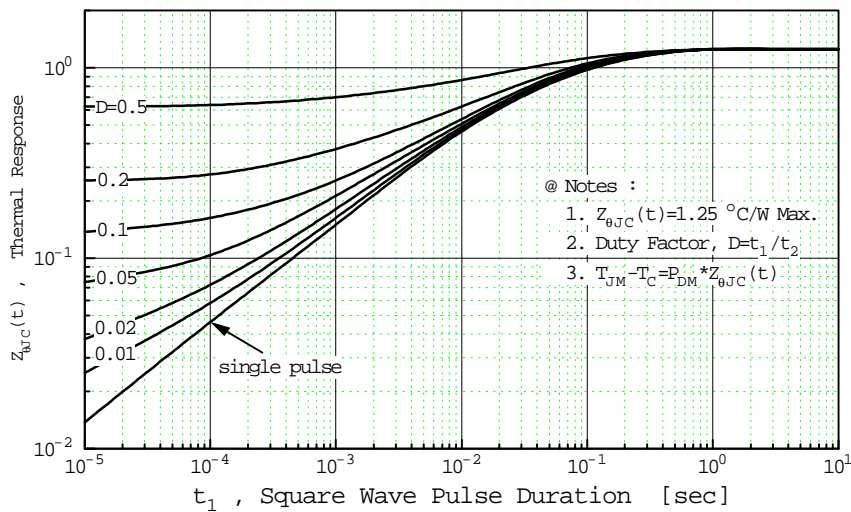
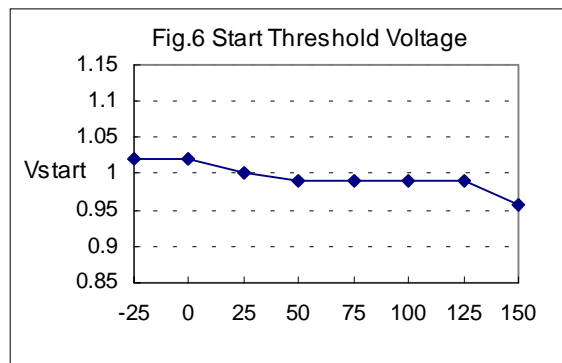
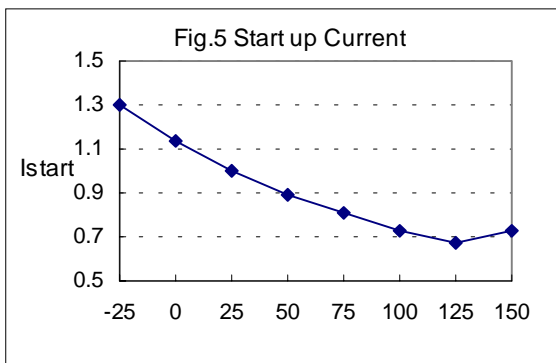
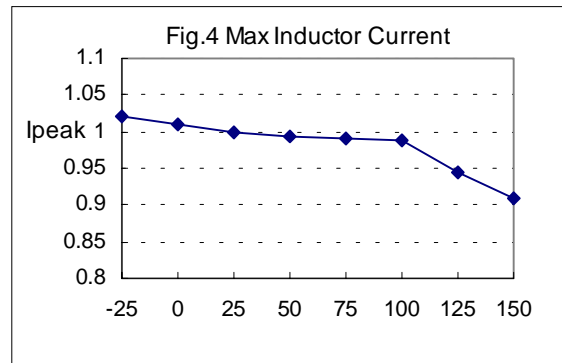
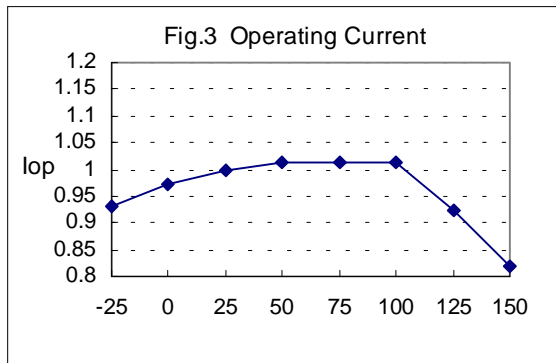
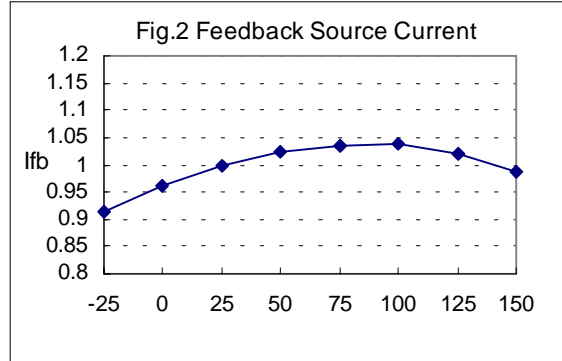
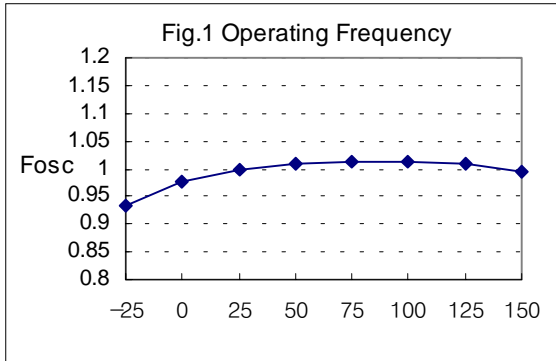

Fig. 11 Thermal Response



TYPICAL PERFORMANCE CHARACTERISTICS (Control part)



TYPICAL PERFORMANCE CHARACTERISTICS (Continued)

(These characteristic graphs are normalized at $T_a=25^\circ\text{C}$)

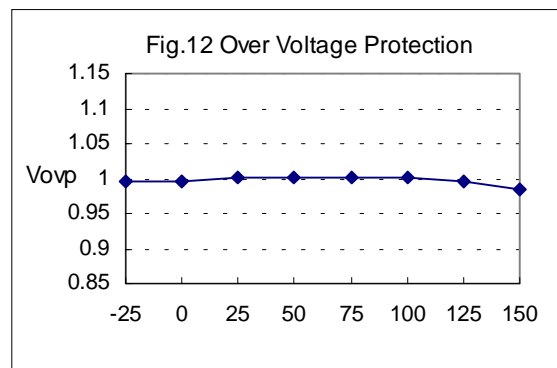
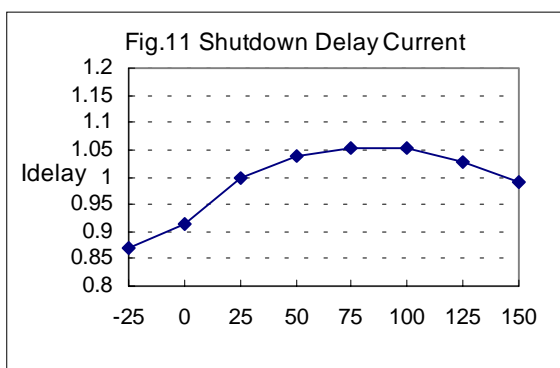
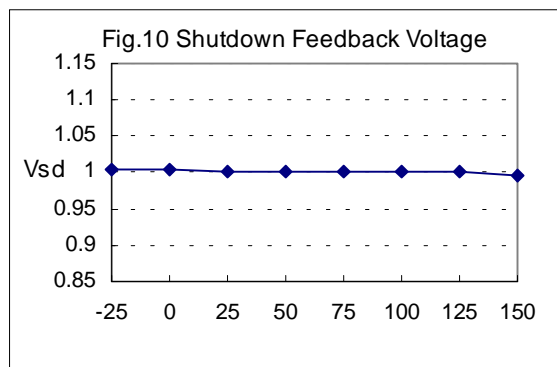
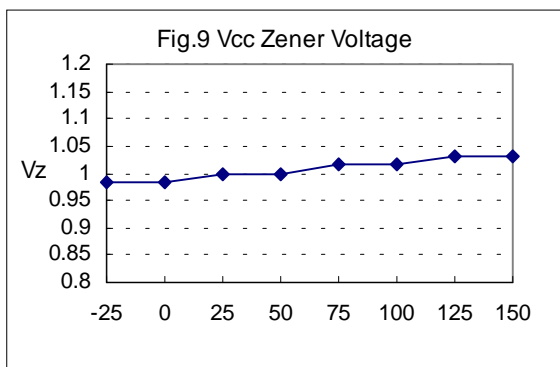
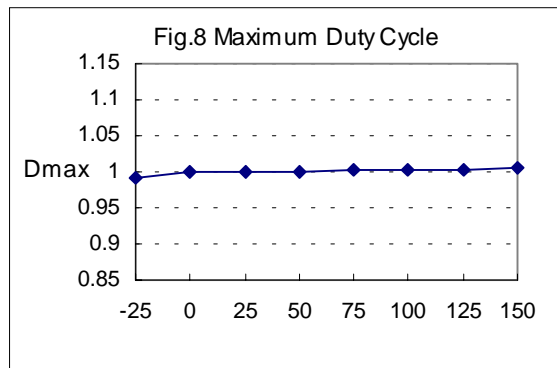
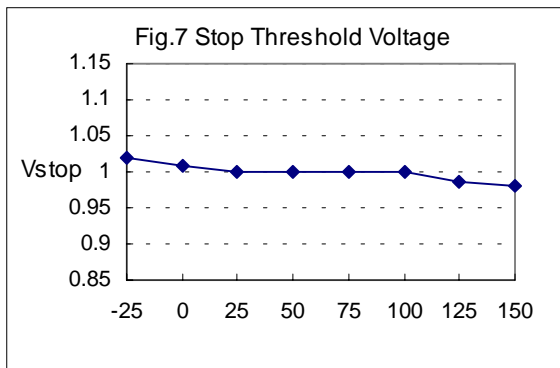

TYPICAL PERFORMANCE CHARACTERISTICS (Continued)

(These characteristic graphs are normalized at Ta=25°C)

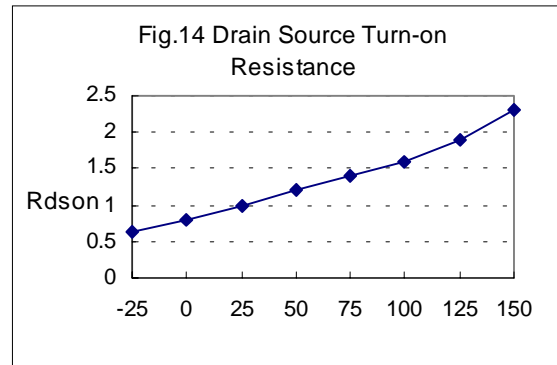
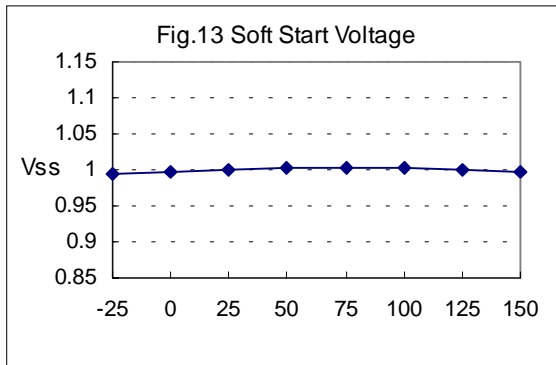

LIFE SUPPORT POLICY

FAIRCHILD'S PRODUCTS ARE NOT AUTHORIZED FOR USE AS CRITICAL COMPONENTS IN LIFE SUPPORT DEVICES OR SYSTEMS WITHOUT THE EXPRESS WRITTEN APPROVAL OF THE PRESIDENT OF FAIRCHILD SEMICONDUCTOR CORPORATION. As used herein:

1. Life support devices or systems are devices or systems which, (a) are intended for surgical implant into the body, or (b) support or sustain life, and (c) whose failure to perform when properly used in accordance with instructions for use provided in the labeling, can be reasonably expected to result in a significant injury of the user.
2. A critical component in any component of a life support device or system whose failure to perform can be reasonably expected to cause the failure of the life support device or system, or to affect its safety or effectiveness.