

MA3810

OUTLINE DIMENSIONS

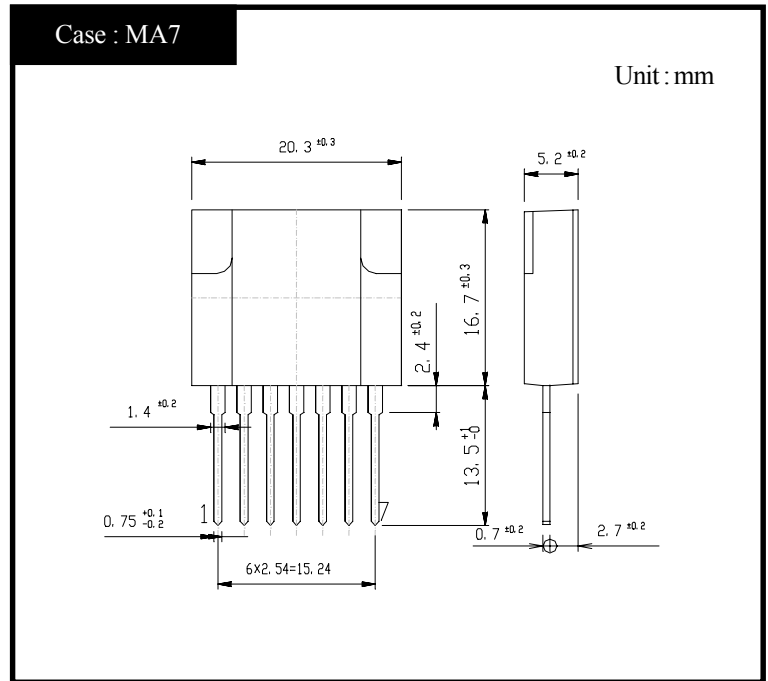

RATINGS

●Absolute Maximum Ratings

Item	Symbol	Conditions	Ratings	Unit
Storage Temperature	T _{stg}		-30~125	°C
Operating Temperature	T _{op}		-20~125	°C
Junction Temperature	T _j		150	°C
Peak Input Voltage	V _{in}	②+,④-,Fig.1 is Measurement Circuit of Peak Input Voltage V _{in} and Collector Cutoff Current I _{CEX} .	850	V
Input Current	I _{in}	DC ②+,④-	2	A
Maximum Power Dissipation	P _D	Pulse ②+,④- Pulse Width 150 μs MAX, Duty 1/2, Sawtooth Wave, Peak Value.	4	A
	P _D	T _a =25°C	3	W
	P _D	Heatsink T _c =100°C	14	W
Dielectric Strength	V _{dis}	Terminals To Case AC 1 min	2	kV
Insulation Resistance		Terminals To Case 500VDC	100	MΩ
Max Voltage ④ to ⑦	V④•⑦	④+,⑦-	6	V
Max Current ⑥ to ④	I⑥•④	⑥+,④- (Peak) Duty Max 3/5	100	mA
Max Current ⑤ to ④	I⑤•④	⑤+,④- (Q ₂ Collector Current)	500	mA

●Electrical Characteristics (T_c=25°C)

Item	Symbol	Conditions	Ratings	Unit	
Q1	Collector Cutoff Current	I _{CEX}	V _{CE} =850V, Fig.1 is Measurement Circuit of Peak Input Voltage V _{in} and Collector Cutoff Current I _{CEX} . , ②+,④-	MAX 100	μA
	DC Current Gain	h _{FE}	V _{CE} = 5V, I _C = 1.0A, ②+,④-,⑤I _B	11~22	
	Collector to Emitter Saturation Voltage	V _{CE(sat)}	I _C =1.0A, I _B =0.2A, ②+,④-,⑤I _B	MAX 1.0	V
	Driving Saturation Voltage	V _{D(sat)}	I _C =1.5A, I _B =0.2A, ②+,④-,⑤I _B	MIN 1.7	V
				MAX 2.3	V
Thermal Resistance	θ _{jc}	Junction to Case	MAX 3.5	°C/W	

●Standard Operating Condition • Design Standard For Application Circuit

Item	Conditions	Ratings	Unit
Input Rated Voltage		AC175~276	V
Output Nominal Wattage		40	W
Output Nominal Voltage		12	V
Output Nominal Current		3.3	A

●Standard Operating Condition • Standard Operating Characteristics (Ta=25°C)

Item	Conditions	Ratings	Unit		
AC Input Voltage	$I_O=3.3A, 10.5V \leq V_O \leq 12.6V$	MAX 175	V		
Minimum Input Full Load Output Voltage	$V_{in}=180V, I_O=3.3A$	12.0 ± 0.6	V	Fig 2, ① Refer	
Maximum Input Light Load Output Voltage	$V_{in}=276V, I_O=0.0A$	12.0 ± 0.6	V	Fig 2, ② Refer	
Over Current Protection	Foldback Current	$V_{in}=276V, V_O=10V$	MAX 5.3	A	Fig 2, ③ Refer
	Short Circuit	$V_{in}=276V, R_O=0.5 \Omega$	Nodamage To Any Device, Automatic Recovery.	-	Fig 2, ④ Refer

Figure in ○=Terminal Sign

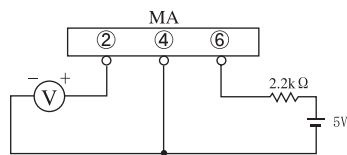

Fig1. Measurement Circuit

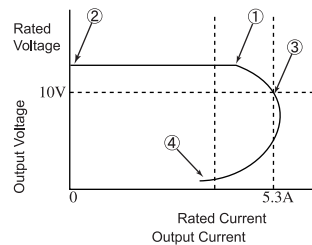
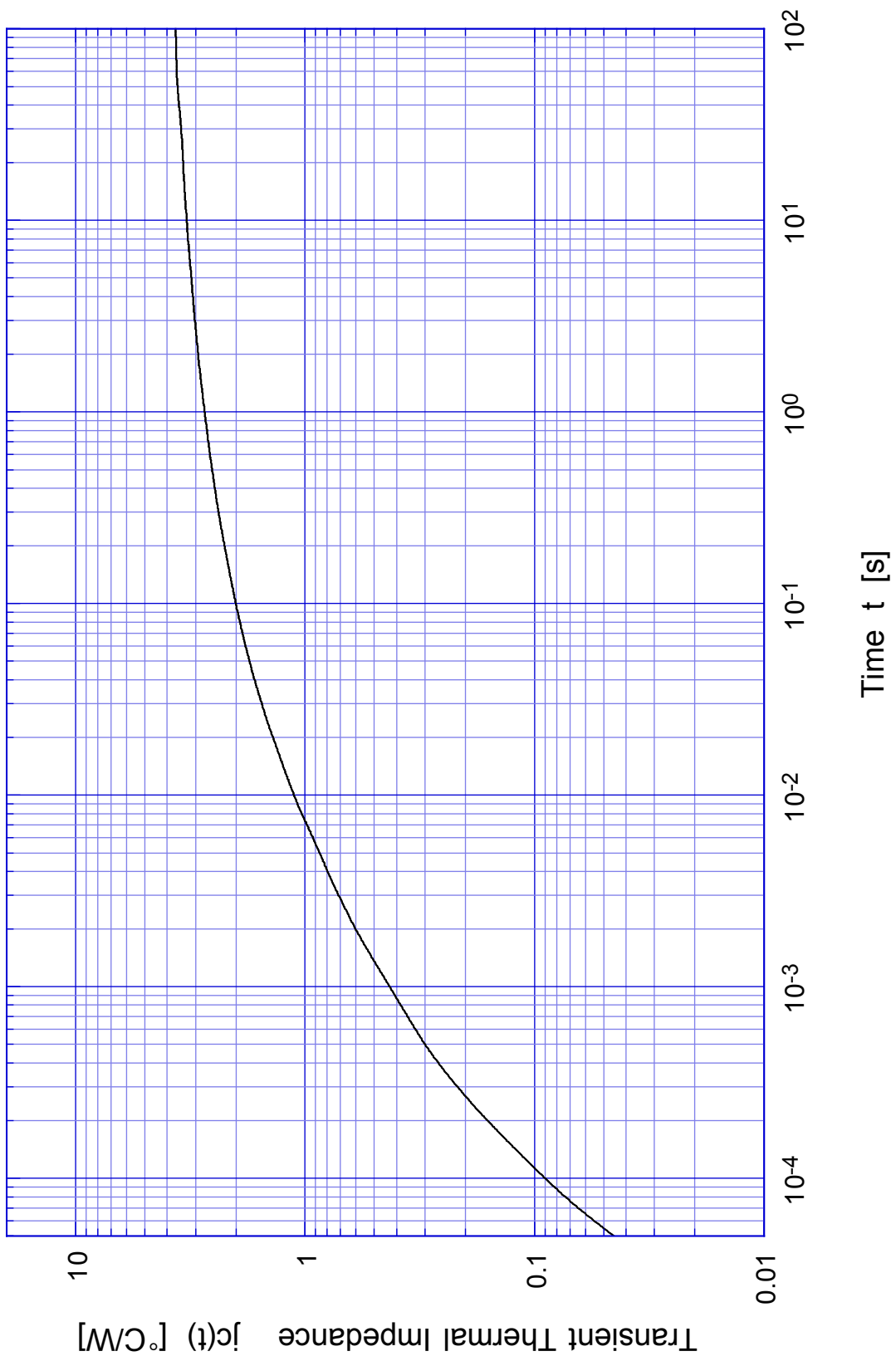

Fig2. Output Voltage/Current

MA3810 Transient Thermal Impedance



MA3810

Forward Bias SOA

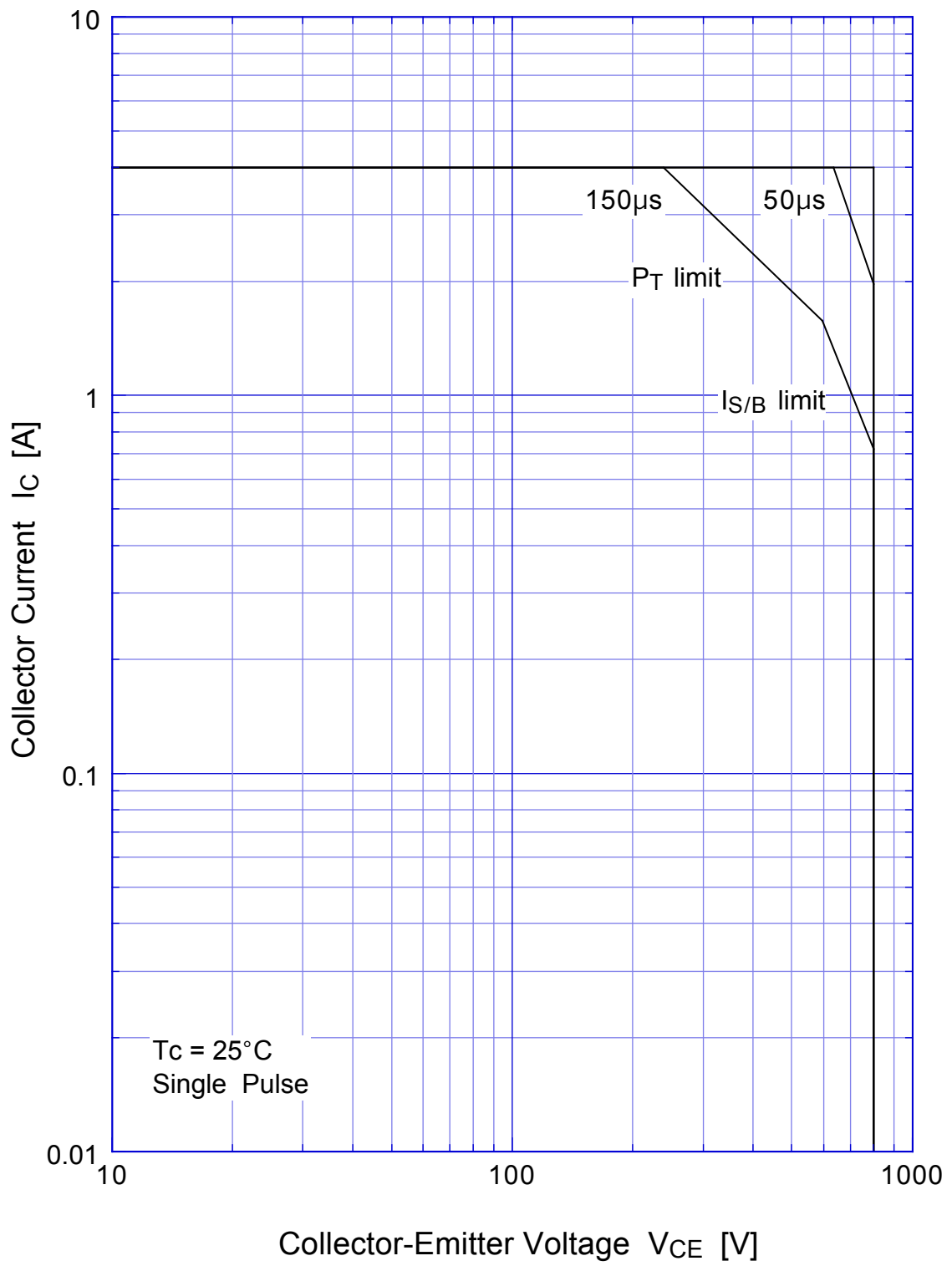

MA3810

Collector Current Derating

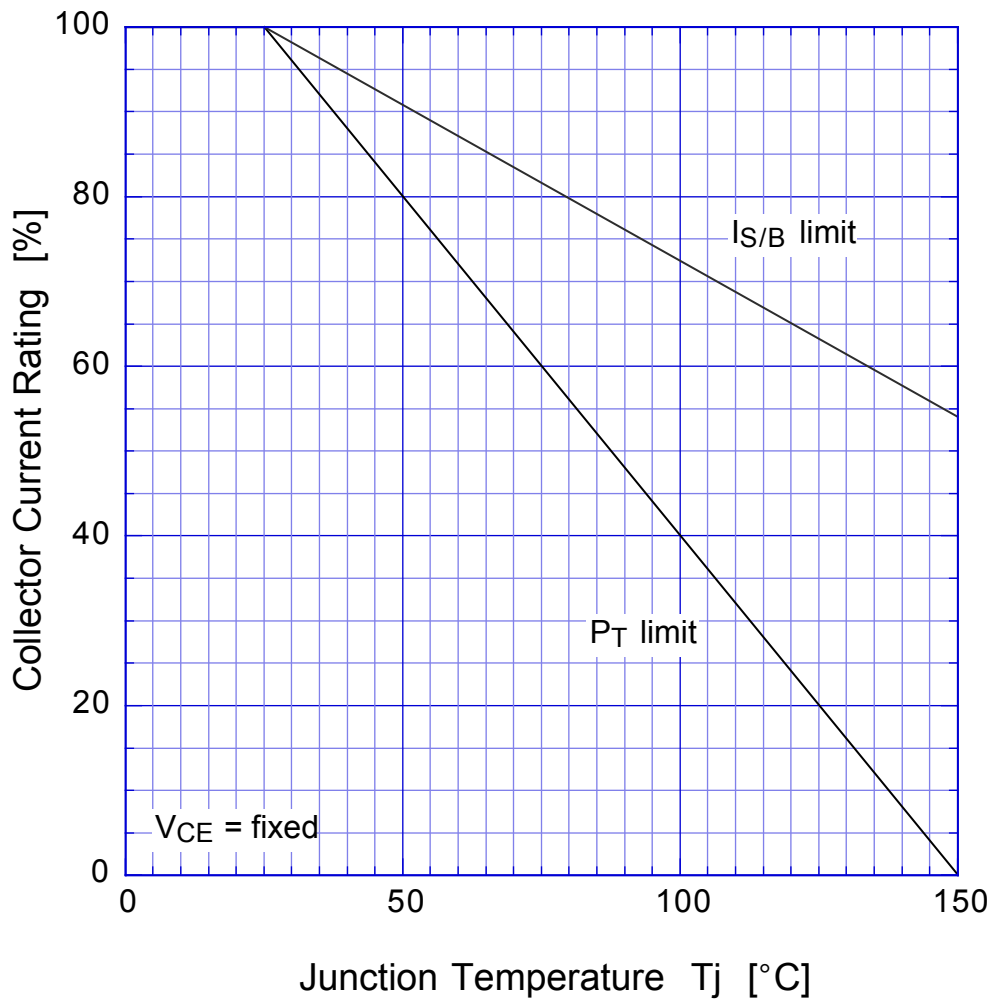

MA3810

Reverse Bias SOA

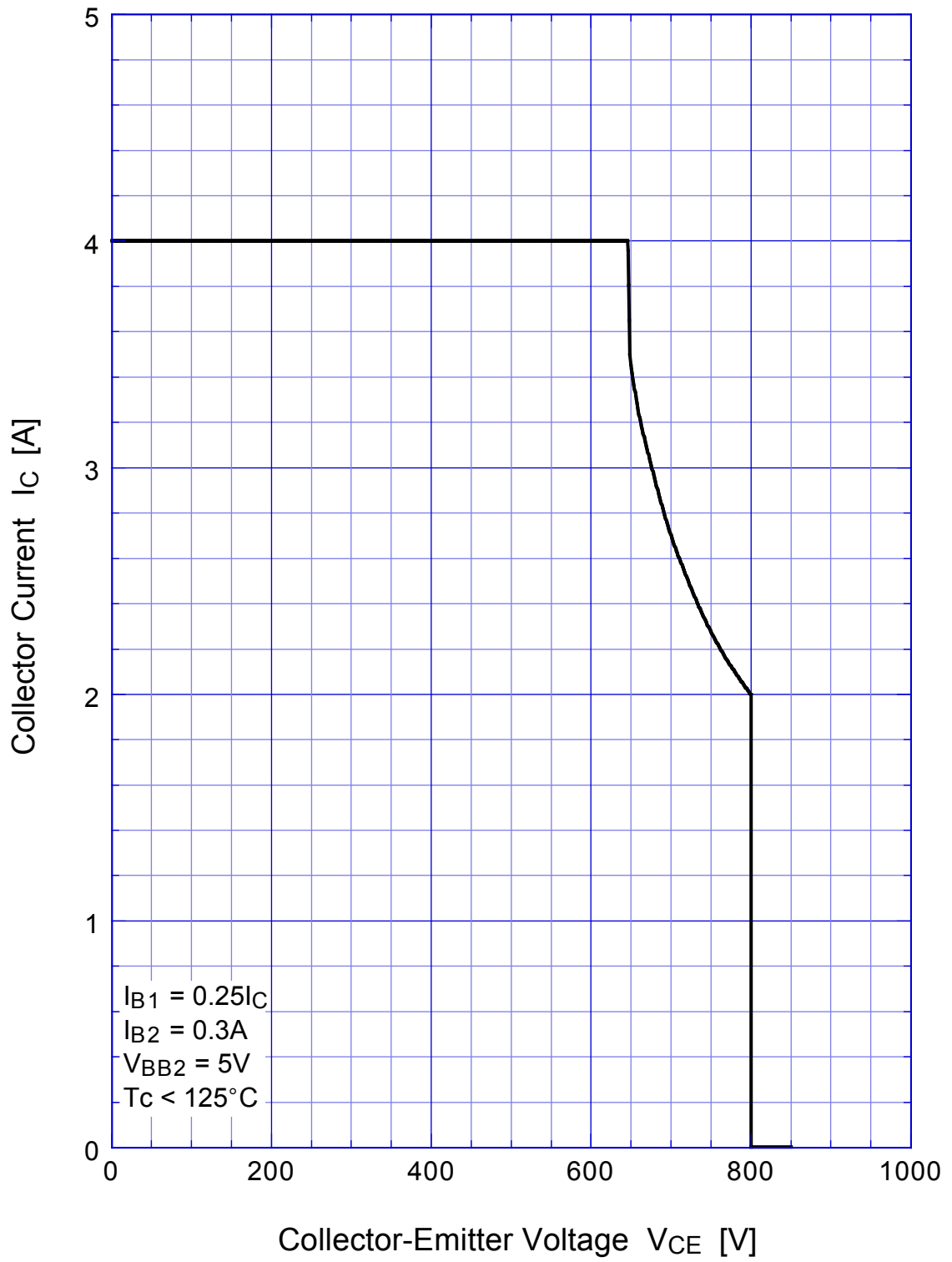

MA3810

$h_{FE} - I_C$

