

# NCV4275

## 5.0 V Low-Drop Voltage Regulator

This industry standard linear regulator has the capability to drive loads up to 450 mA at 5.0 V. It is available in DPAK and D<sup>2</sup>PAK. This device is pin-for-pin compatible with Infineon part number TLE4275.

### Features

- 5.0 V,  $\pm 2\%$ , 450 mA Output Voltage
- Very Low Current Consumption
- Active  $\overline{\text{RESET}}$
- Reset Low Down to  $V_Q = 1.0$  V
- 500 mV (max) Dropout Voltage
- Fault Protection
  - ◆ +45 V Peak Transient Voltage
  - ◆ -42 V Reverse Voltage
  - ◆ Short Circuit
  - ◆ Thermal Overload
- NCV Prefix for Automotive and Other Applications Requiring Site and Control Changes

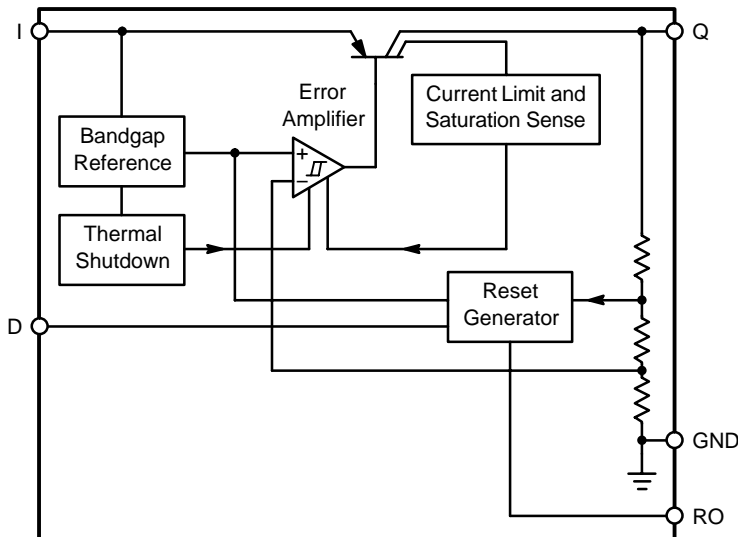

Figure 1. Block Diagram



ON Semiconductor®

<http://onsemi.com>

### MARKING DIAGRAMS

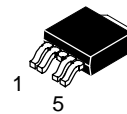

DPAK  
5-PIN  
DT SUFFIX  
CASE 175AA

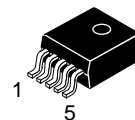
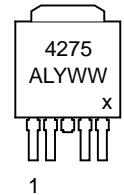

D<sup>2</sup>PAK  
5-PIN  
DS SUFFIX  
CASE 936A

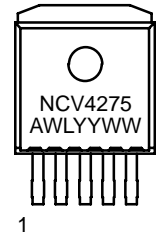

Pin 1. I  
2. RO  
Tab, 3. GND\*  
4. D  
5. Q

\* Tab is connected to Pin 3 on all packages

A = Assembly Location  
WL, L = Wafer Lot  
YY, Y = Year  
WW = Work Week

### ORDERING INFORMATION

Device	Package	Shipping†
NCV4275DT	DPAK	75 Units/Rail
NCV4275DTRK	DPAK	2500 Tape & Reel
NCV4275DS	D <sup>2</sup> PAK	50 Units/Rail
NCV4275DSR4	D <sup>2</sup> PAK	800 Tape & Reel

†For information on tape and reel specifications, including part orientation and tape sizes, please refer to our Tape and Reel Packaging Specification Brochure, BRD8011/D.

# NCV4275

## PIN FUNCTION DESCRIPTION

Pin No.	Symbol	Description
1	I	Input; Battery Supply Input Voltage. Bypass to ground with a ceramic capacitor.
2	RO	Reset Output; Open Collector Active Reset (accurate when I > 1.0 V).
3	GND	Ground; Pin 3 internally connected to tab.
4	D	Reset Delay; timing capacitor to GND for Reset Delay function.
5	Q	Output; $\pm 2.0\%$ , 450 mA output. Use 22 $\mu$ F, ESR < 5.0 $\Omega$ to ground.

## MAXIMUM RATINGS†

Rating	Min	Max	Unit	
Input [I (DC)]	-42	45	V	
Input [I (Peak Transient Voltage)]	-	45	V	
Output (Q)	-1.0	16	V	
Reset Output (RO)	-0.3	25	V	
Reset Output (RO)	-5.0	5.0	mA	
Reset Delay (D)	-0.3	7.0	V	
Reset Delay (D)	-2.0	2.0	mA	
Operating Range (I)	5.5	42	V	
ESD Susceptibility (Human Body Model)	2.0	-	kV	
Junction Temperature	-40	150	°C	
Storage Temperature	-55	150	°C	
Lead Temperature Soldering				
	Reflow (SMD styles only) Note 1	-	240 Peak (Note 3)	°C
	Wave Solder (through hole styles only) Note 2	-	260 Peak	°C

Maximum ratings are those values beyond which device damage can occur. Maximum ratings applied to the device are individual stress limit values (not normal operating conditions) and are not valid simultaneously. If these limits are exceeded, device functional operation is not implied, damage may occur and reliability may be affected.

## THERMAL CHARACTERISTICS

Parameter	Test Conditions (Typical Value)	Unit
-----------	---------------------------------	------

### DPAK 5-PIN PACKAGE

	Min Pad Board (Note 4)	1" Pad Board (Note 5)	
Junction-to-Tab ( $\psi_{JLX}$ , $\psi_{JLX}$ )	4.2	4.7	C/W
Junction-to-Ambient ( $R_{\theta JA}$ , $\theta_{JA}$ )	100.9	46.8	C/W

### D<sup>2</sup>PAK 5-PIN PACKAGE

	0.4 sq. in. Spreader Board (Note 6)	1.2 sq. in. Spreader Board (Note 7)	
Junction-to-Tab ( $\psi_{JLX}$ , $\psi_{JLX}$ )	3.8	4.0	C/W
Junction-to-Ambient ( $R_{\theta JA}$ , $\theta_{JA}$ )	74.8	41.6	C/W

- 60 seconds max above 183°C.
- 10 seconds max.
- 5°C/+0°C allowable conditions.
- 1 oz. copper, 0.26 inch<sup>2</sup> (168 mm<sup>2</sup>) copper area, 0.62" thick FR4.
- 1 oz. copper, 1.14 inch<sup>2</sup> (736 mm<sup>2</sup>) copper area, 0.62" thick FR4.
- 1 oz. copper, 0.373 inch<sup>2</sup> (241 mm<sup>2</sup>) copper area, 0.62" thick FR4.
- 1 oz. copper, 1.222 inch<sup>2</sup> (788 mm<sup>2</sup>) copper area, 0.62" thick FR4.

†During the voltage range which exceeds the maximum tested voltage of I, operation is assured, but not specified. Wider limits may apply. Thermal dissipation must be observed closely.

# NCV4275

## ELECTRICAL CHARACTERISTICS (I = 13.5 V; -40°C < T<sub>J</sub> < 150°C; unless otherwise noted)

Characteristic	Test Conditions	Min	Typ	Max	Unit
<b>Output</b>					
Output Voltage	5.0 mA < I <sub>Q</sub> < 400 mA, 6.0 V < V <sub>I</sub> < 28 V	4.9	5.0	5.1	V
Output Voltage	5.0 mA < I <sub>Q</sub> < 200 mA, 6.0 V < V <sub>I</sub> < 40 V	4.9	5.0	5.1	V
Output Current Limitation	-	450	700	-	mA
Quiescent Current, I <sub>Q</sub> = I <sub>I</sub> - I <sub>Q</sub>	I <sub>Q</sub> = 1.0 mA	-	150	200	μA
Quiescent Current, I <sub>Q</sub> = I <sub>I</sub> - I <sub>Q</sub>	I <sub>Q</sub> = 250 mA	-	10	15	mA
Quiescent Current, I <sub>Q</sub> = I <sub>I</sub> - I <sub>Q</sub>	I <sub>Q</sub> = 400 mA	-	23	35	mA
Dropout Voltage	I <sub>Q</sub> = 300 mA, V <sub>dr</sub> = V <sub>I</sub> - V <sub>Q</sub>	-	250	500	mV
Load Regulation	I <sub>Q</sub> = 5.0 mA to 400 mA	-30	15	30	mV
Line Regulation	ΔV = 8.0 V to 32 V, I <sub>Q</sub> = 5.0 mA	-25	5.0	25	mV
Power Supply Ripple Rejection	f <sub>r</sub> = 100 Hz, V <sub>r</sub> = 0.5 V <sub>pp</sub>	-	60	-	dB
Temperature Output Voltage Drift	-	-	0.5	-	mV/k

### Reset Timing D and Output RO

Reset Switching Threshold	-	4.5	4.65	4.8	V
Reset Output Low Voltage	R <sub>ext</sub> > 5.0 k, V <sub>Q</sub> > 1.0 V	-	0.2	0.4	V
Reset Output Leakage Current	V <sub>ROH</sub> = 5.0 V	-	0	10	μA
Reset Charging Current	V <sub>D</sub> = 1.0 V	3.0	5.5	9.0	μA
Upper Timing Threshold	-	1.5	1.8	2.2	V
Lower Timing Threshold	-	0.2	0.4	0.7	V
Reset Delay Time	C <sub>D</sub> = 47 nF	10	16	22	ms
Reset Reaction Time	C <sub>D</sub> = 47 nF	-	1.5	4.0	μs

## TYPICAL PERFORMANCE CHARACTERISTICS

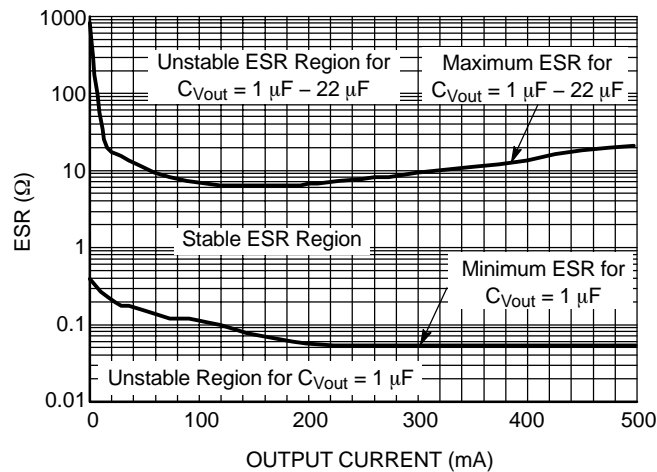

Figure 2. Output Stability with Output Capacitor ESR

APPLICATION INFORMATION

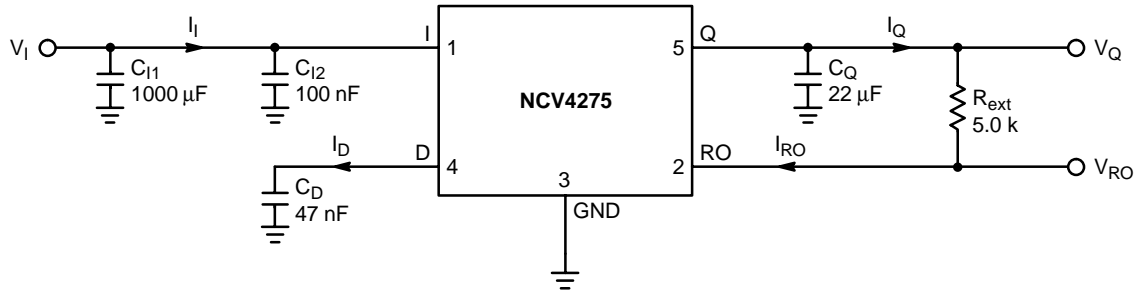

Figure 3. Test Circuit

**Circuit Description**

The error amplifier compares a temperature-stable reference voltage to a voltage that is proportional to the output voltage (Q) (generated from a resistor divider) and drives the base of a series transistor via a buffer. Saturation control as a function of the load current prevents oversaturation of the output power device, thus preventing excessive substrate current (quiescent current).

Typical drop out voltage at 300 mA load is 250 mV, 500 mV maximum. Test voltage for drop out is 5.0 V input.

**Stability Considerations**

The input capacitors (C<sub>I1</sub> and C<sub>I2</sub>) are necessary to control line influences. Using a resistor of approximately 1.0 Ω in series with C<sub>I2</sub> can solve potential oscillations due to stray inductance and capacitance.

The output or compensation capacitor helps determine three main characteristics of a linear regulator: start-up delay, load transient response and loop stability.

The capacitor value and type should be based on cost, availability, size and temperature constraints. A tantalum or aluminum electrolytic capacitor is best, since a film or ceramic capacitor with almost zero ESR can cause instability. The aluminum electrolytic capacitor is the least expensive solution, but, if the circuit operates at low temperatures (-25°C to -40°C), both the value and ESR of the capacitor will vary considerably. The capacitor manufacturers data sheet usually provides this information.

The value for the output capacitor C<sub>Q</sub> shown in Figure 3 should work for most applications, however it is not necessarily the optimized solution. Stability is guaranteed for C<sub>Q</sub> > 22 μF and an ESR ≤ 5.0 Ω

**Calculating Power Dissipation in a Single Output Linear Regulator**

The maximum power dissipation for a single output regulator (Figure 4) is:

$$PD(max) = [V_I(max) - V_Q(min)]I_Q(max) + V_I(max)I_q \quad (1)$$

where

- V<sub>I(max)</sub> is the maximum input voltage,
- V<sub>Q(min)</sub> is the minimum output voltage,
- I<sub>Q(max)</sub> is the maximum output current for the application,
- I<sub>q</sub> is the quiescent current the regulator consumes at I<sub>Q(max)</sub>.

Once the value of P<sub>D(max)</sub> is known, the maximum permissible value of R<sub>θJA</sub> can be calculated:

$$R_{\theta JA} = \frac{150^{\circ}C - T_A}{P_D} \quad (2)$$

The value of R<sub>θJA</sub> can then be compared with those in the package section of the data sheet. Those packages with R<sub>θJA</sub>'s less than the calculated value in Equation 2 will keep the die temperature below 150°C.

In some cases, none of the packages will be sufficient to dissipate the heat generated by the IC, and an external heatsink will be required.

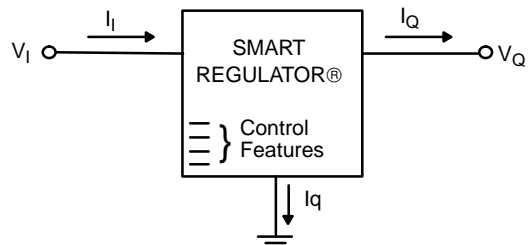

Figure 4. Single Output Regulator with Key Performance Parameters Labeled

**Heat Sinks**

A heat sink effectively increases the surface area of the package to improve the flow of heat away from the IC and into the surrounding air.

Each material in the heat flow path between the IC and the outside environment will have a thermal resistance. Like series electrical resistances, these resistances are summed to determine the value of  $R_{\theta JA}$ :

$$R_{\theta JA} = R_{\theta JC} + R_{\theta CS} + R_{\theta SA} \quad (3)$$

where

- $R_{\theta JC}$  is the junction-to-case thermal resistance,
- $R_{\theta CS}$  is the case-to-heatsink thermal resistance,
- $R_{\theta SA}$  is the heatsink-to-ambient thermal resistance.

$R_{\theta JC}$  appears in the package section of the data sheet. Like  $R_{\theta JA}$ , it too is a function of package type.  $R_{\theta CS}$  and  $R_{\theta SA}$  are functions of the package type, heatsink and the interface between them. These values appear in heat sink data sheets of heat sink manufacturers.

Thermal, mounting, and heatsinking considerations are discussed in the ON Semiconductor application note AN1040/D.

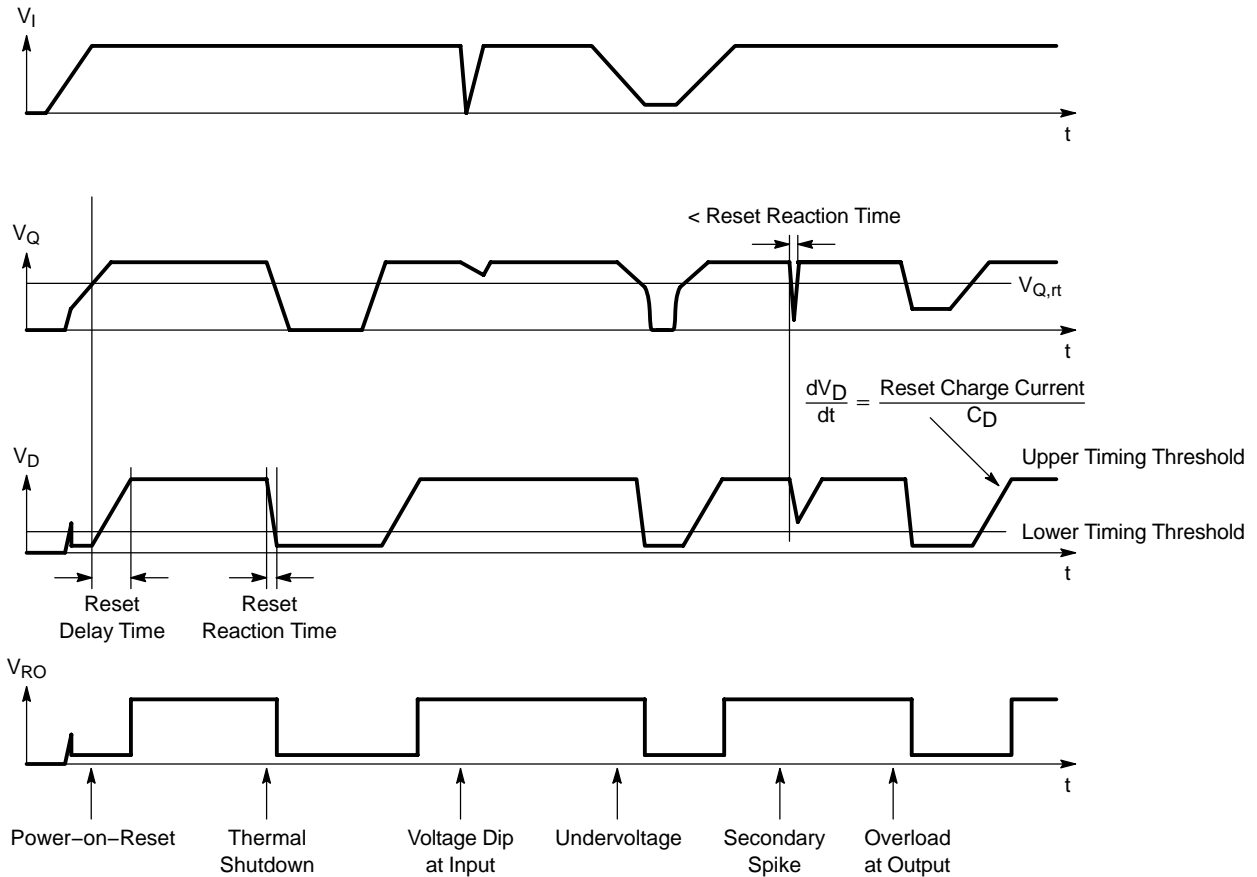

**Figure 5. Reset Timing**

# NCV4275

**Table 1. DPAK 5-Lead Thermal RC Network Models**

Drain Copper Area (1 oz thick)			168 mm <sup>2</sup>	736 mm <sup>2</sup>		168 mm <sup>2</sup>	736 mm <sup>2</sup>	
(SPICE Deck Format)			Cauer Network			Foster Network		
			168 mm <sup>2</sup>	736 mm <sup>2</sup>	Units	Tau	Tau	Units
<b>C_C1</b>	<b>Junction</b>	<b>Gnd</b>	1.00E-06	1.00E-06	W-s/C	1.36E-08	1.361E-08	sec
<b>C_C2</b>	<b>node1</b>	<b>Gnd</b>	1.00E-05	1.00E-05	W-s/C	7.41E-07	7.411E-07	sec
<b>C_C3</b>	<b>node2</b>	<b>Gnd</b>	6.00E-05	6.00E-05	W-s/C	1.04E-05	1.029E-05	sec
<b>C_C4</b>	<b>node3</b>	<b>Gnd</b>	1.00E-04	1.00E-04	W-s/C	3.91E-05	3.737E-05	sec
<b>C_C5</b>	<b>node4</b>	<b>Gnd</b>	4.36E-04	3.64E-04	W-s/C	1.80E-03	1.376E-03	sec
C_C6	node5	Gnd	6.77E-02	1.92E-02	W-s/C	3.77E-01	2.851E-02	sec
C_C7	node6	Gnd	1.51E-01	1.27E-01	W-s/C	3.79E+00	9.475E-01	sec
C_C8	node7	Gnd	4.80E-01	1.018	W-s/C	2.65E+01	1.173E+01	sec
C_C9	node8	Gnd	3.740	2.955	W-s/C	8.71E+01	8.59E+01	sec
C_C10	node9	Gnd	10.322	0.438	W-s/C			sec
			168 mm <sup>2</sup>	736 mm <sup>2</sup>		R's	R's	
<b>R_R1</b>	<b>Junction</b>	<b>node1</b>	0.015	0.015	C/W	0.0123	0.0123	C/W
<b>R_R2</b>	<b>node1</b>	<b>node2</b>	0.08	0.08	C/W	0.0585	0.0585	C/W
<b>R_R3</b>	<b>node2</b>	<b>node3</b>	0.4	0.4	C/W	0.0304	0.0287	C/W
<b>R_R4</b>	<b>node3</b>	<b>node4</b>	0.2	0.2	C/W	0.3997	0.3772	C/W
<b>R_R5</b>	<b>node4</b>	<b>node5</b>	2.97519	2.6171	C/W	3.115	2.68	C/W
R_R6	node5	node6	8.2971	1.6778	C/W	3.571	1.38	C/W
R_R7	node6	node7	25.9805	7.4246	C/W	12.851	5.92	C/W
R_R8	node7	node8	46.5192	14.9320	C/W	35.471	7.39	C/W
R_R9	node8	node9	17.7808	19.2560	C/W	46.741	28.94	C/W
R_R10	node9	Gnd	0.1	0.1758	C/W			C/W

NOTE: Bold face items represent the package without the external thermal system.

# NCV4275

**Table 2. D<sup>2</sup>PAK 5-Lead Thermal RC Network Models**

Drain Copper Area (1 oz thick)			241 mm <sup>2</sup>	788 mm <sup>2</sup>		241 mm <sup>2</sup>	788 mm <sup>2</sup>	
(SPICE Deck Format)			Cauer Network			Foster Network		
			241 mm <sup>2</sup>	653 mm <sup>2</sup>	Units	Tau	Tau	Units
<b>C_C1</b>	<b>Junction</b>	<b>Gnd</b>	1.00E-06	1.00E-06	W-s/C	1.361E-08	1.361E-08	sec
<b>C_C2</b>	<b>node1</b>	<b>Gnd</b>	1.00E-05	1.00E-05	W-s/C	7.411E-07	7.411E-07	sec
<b>C_C3</b>	<b>node2</b>	<b>Gnd</b>	6.00E-05	6.00E-05	W-s/C	1.005E-05	1.007E-05	sec
<b>C_C4</b>	<b>node3</b>	<b>Gnd</b>	1.00E-04	1.00E-04	W-s/C	3.460E-05	3.480E-05	sec
<b>C_C5</b>	<b>node4</b>	<b>Gnd</b>	2.82E-04	2.87E-04	W-s/C	7.868E-04	8.107E-04	sec
C_C6	node5	Gnd	5.58E-03	5.95E-03	W-s/C	7.431E-03	7.830E-03	sec
C_C7	node6	Gnd	4.25E-01	4.61E-01	W-s/C	2.786E+00	2.012E+00	sec
C_C8	node7	Gnd	9.22E-01	2.05	W-s/C	2.014E+01	2.601E+01	sec
C_C9	node8	Gnd	1.73	4.88	W-s/C	1.134E+02	1.218E+02	sec
C_C10	node9	Gnd	7.12	1.31	W-s/C			sec
			241 mm <sup>2</sup>	653 mm <sup>2</sup>		R's	R's	
<b>R_R1</b>	<b>Junction</b>	<b>node1</b>	0.015	0.0150	C/W	0.0123	0.0123	C/W
<b>R_R2</b>	<b>node1</b>	<b>node2</b>	0.08	0.0800	C/W	0.0585	0.0585	C/W
<b>R_R3</b>	<b>node2</b>	<b>node3</b>	0.4	0.4000	C/W	0.0257	0.0260	C/W
<b>R_R4</b>	<b>node3</b>	<b>node4</b>	0.2	0.2000	C/W	0.3413	0.3438	C/W
<b>R_R5</b>	<b>node4</b>	<b>node5</b>	1.85638	1.8839	C/W	1.77	1.81	C/W
R_R6	node5	node6	1.23672	1.2272	C/W	1.54	1.52	C/W
R_R7	node6	node7	9.81541	5.3383	C/W	4.13	3.46	C/W
R_R8	node7	node8	33.1868	18.9591	C/W	6.27	5.03	C/W
R_R9	node8	node9	27.0263	13.3369	C/W	60.80	29.30	C/W
R_R10	node9	gnd	1.13944	0.1191	C/W			C/W

NOTE: Bold face items represent the package without the external thermal system.

The Cauer networks generally have physical significance and may be divided between nodes to separate thermal behavior due to one portion of the network from another. The Foster networks, though when sorted by time constant (as above) bear a rough correlation with the Cauer networks, are really only convenient mathematical models. Cauer networks can be easily implemented using circuit simulating tools, whereas Foster networks may be more easily implemented using mathematical tools (for instance, in a spreadsheet program), according to the following formula:

$$R(t) = \sum_{i=1}^n R_i (1 - e^{-t/\tau_i})$$

# NCV4275

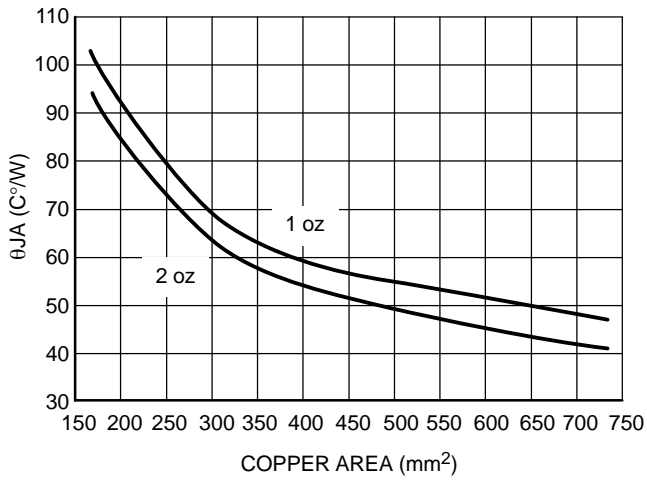

**Figure 6.  $\theta_{JA}$  vs. Copper Spreader Area, DPAK 5-Lead**

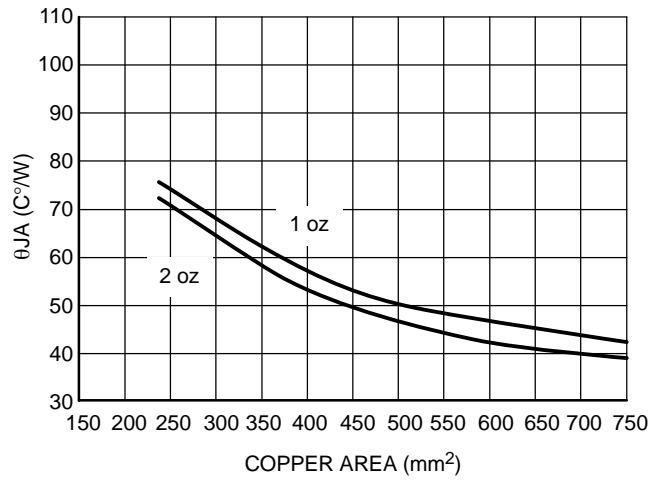

**Figure 7.  $\theta_{JA}$  vs. Copper Spreader Area, D<sup>2</sup>PAK 5-Lead**

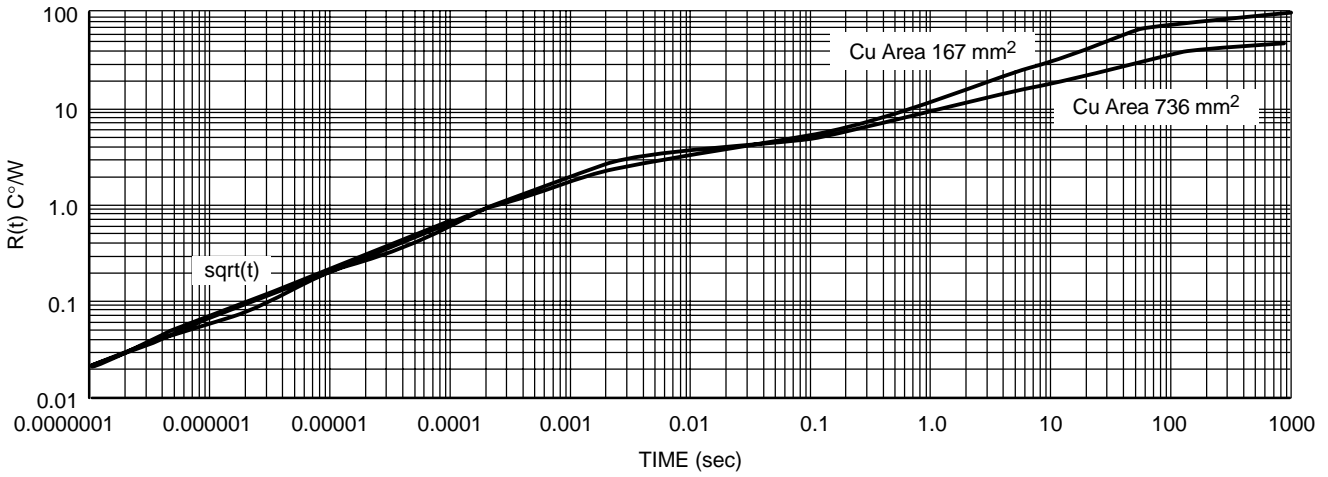

**Figure 8. Single-Pulse Heating Curves, DPAK 5-Lead**

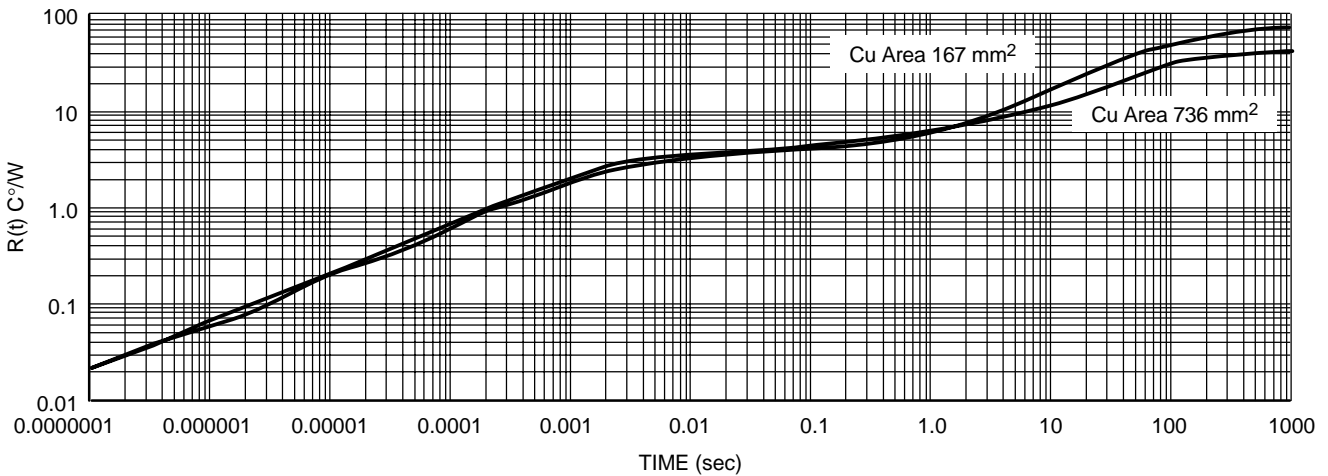

**Figure 9. Single-Pulse Heating Curves, D<sup>2</sup>PAK 5-Lead**



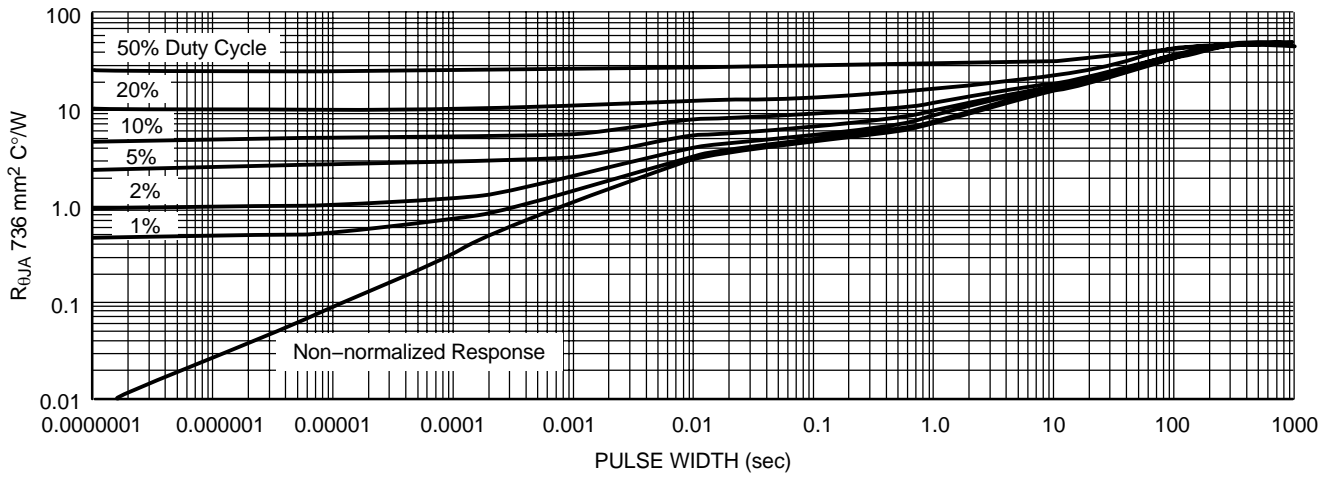

Figure 10. Duty Cycle for 1" Spreader Boards, DPAK 5-Lead

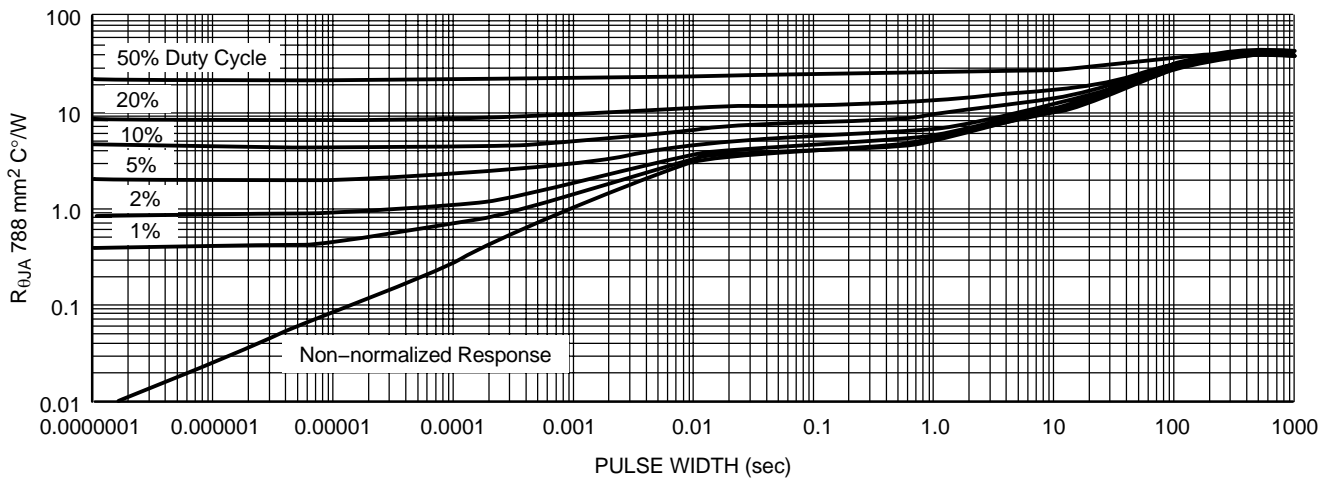

Figure 11. Duty Cycle for 1" Spreader Boards, D<sup>2</sup>PAK 5-Lead

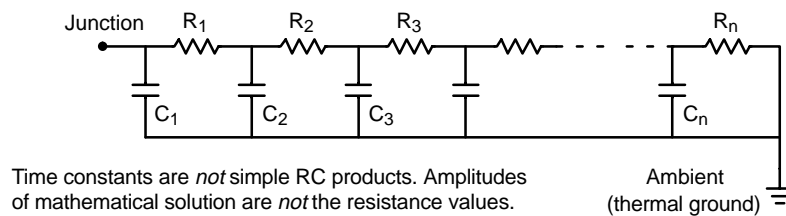

Figure 12. Grounded Capacitor Thermal Network ("Cauer" Ladder)

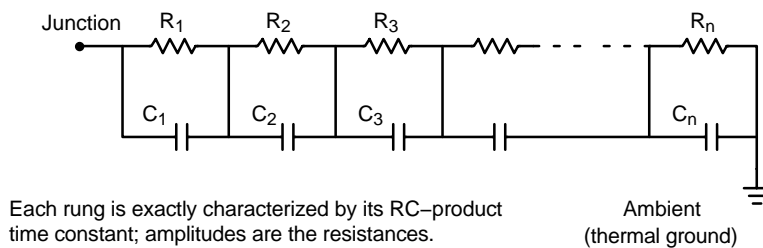
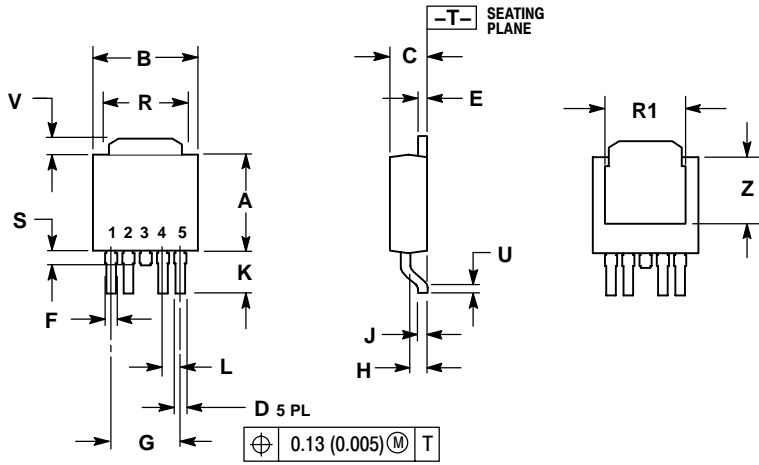

Figure 13. Non-Grounded Capacitor Thermal Ladder ("Foster" Ladder)

# NCV4275

## PACKAGE DIMENSIONS

**DKPAK 5 CENTER LEAD CROP**  
**DT SUFFIX**  
 CASE 175AA-01  
 ISSUE O



- NOTES:
1. DIMENSIONING AND TOLERANCING PER ANSI Y14.5M, 1982.
  2. CONTROLLING DIMENSION: INCH.

DIM	INCHES		MILLIMETERS	
	MIN	MAX	MIN	MAX
A	0.235	0.245	5.97	6.22
B	0.250	0.265	6.35	6.73
C	0.086	0.094	2.19	2.38
D	0.020	0.028	0.51	0.71
E	0.018	0.023	0.46	0.58
F	0.024	0.032	0.61	0.81
G	0.180 BSC		4.56 BSC	
H	0.034	0.040	0.87	1.01
J	0.018	0.023	0.46	0.58
K	0.102	0.114	2.60	2.89
L	0.045 BSC		1.14 BSC	
R	0.170	0.190	4.32	4.83
R1	0.185	0.210	4.70	5.33
S	0.025	0.040	0.63	1.01
U	0.020	---	0.51	---
V	0.035	0.050	0.89	1.27
Z	0.155	0.170	3.93	4.32

# NCV4275

## PACKAGE DIMENSIONS

D<sup>2</sup>PAK  
5 LEAD  
DS SUFFIX  
CASE 936A-02  
ISSUE B

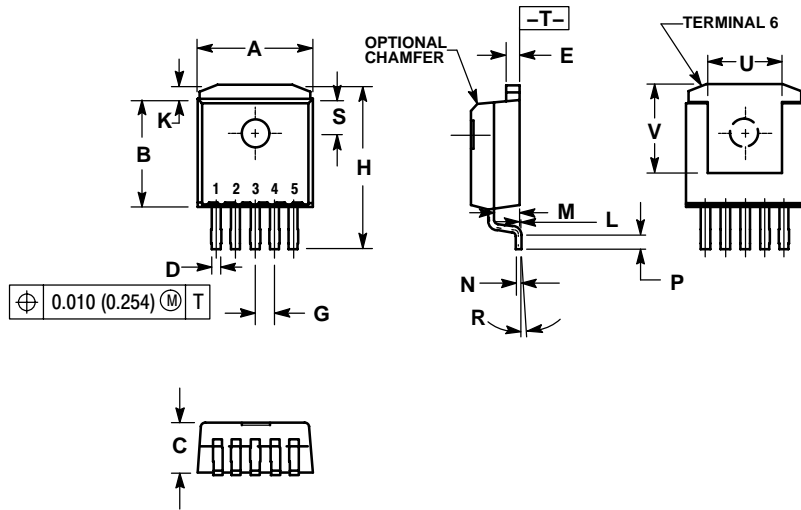

### NOTES:

1. DIMENSIONING AND TOLERANCING PER ANSI Y14.5M, 1982.
2. CONTROLLING DIMENSION: INCH.
3. TAB CONTOUR OPTIONAL WITHIN DIMENSIONS A AND K.
4. DIMENSIONS U AND V ESTABLISH A MINIMUM MOUNTING SURFACE FOR TERMINAL 6.
5. DIMENSIONS A AND B DO NOT INCLUDE MOLD FLASH OR GATE PROTRUSIONS. MOLD FLASH AND GATE PROTRUSIONS NOT TO EXCEED 0.025 (0.635) MAXIMUM.

DIM	INCHES		MILLIMETERS	
	MIN	MAX	MIN	MAX
A	0.386	0.403	9.804	10.236
B	0.356	0.368	9.042	9.347
C	0.170	0.180	4.318	4.572
D	0.026	0.036	0.660	0.914
E	0.045	0.055	1.143	1.397
G	0.067 BSC		1.702 BSC	
H	0.539	0.579	13.691	14.707
K	0.050 REF		1.270 REF	
L	0.000	0.010	0.000	0.254
M	0.088	0.102	2.235	2.591
N	0.018	0.026	0.457	0.660
P	0.058	0.078	1.473	1.981
R	5° REF		5° REF	
S	0.116 REF		2.946 REF	
U	0.200 MIN		5.080 MIN	
V	0.250 MIN		6.350 MIN	

**ON Semiconductor** and  are registered trademarks of Semiconductor Components Industries, LLC (SCILLC). SCILLC reserves the right to make changes without further notice to any products herein. SCILLC makes no warranty, representation or guarantee regarding the suitability of its products for any particular purpose, nor does SCILLC assume any liability arising out of the application or use of any product or circuit, and specifically disclaims any and all liability, including without limitation special, consequential or incidental damages. "Typical" parameters which may be provided in SCILLC data sheets and/or specifications can and do vary in different applications and actual performance may vary over time. All operating parameters, including "Typicals" must be validated for each customer application by customer's technical experts. SCILLC does not convey any license under its patent rights nor the rights of others. SCILLC products are not designed, intended, or authorized for use as components in systems intended for surgical implant into the body, or other applications intended to support or sustain life, or for any other application in which the failure of the SCILLC product could create a situation where personal injury or death may occur. Should Buyer purchase or use SCILLC products for any such unintended or unauthorized application, Buyer shall indemnify and hold SCILLC and its officers, employees, subsidiaries, affiliates, and distributors harmless against all claims, costs, damages, and expenses, and reasonable attorney fees arising out of, directly or indirectly, any claim of personal injury or death associated with such unintended or unauthorized use, even if such claim alleges that SCILLC was negligent regarding the design or manufacture of the part. SCILLC is an Equal Opportunity/Affirmative Action Employer. This literature is subject to all applicable copyright laws and is not for resale in any manner.

## PUBLICATION ORDERING INFORMATION

### LITERATURE FULFILLMENT:

Literature Distribution Center for ON Semiconductor  
P.O. Box 61312, Phoenix, Arizona 85082-1312 USA  
**Phone:** 480-829-7710 or 800-344-3860 Toll Free USA/Canada  
**Fax:** 480-829-7709 or 800-344-3867 Toll Free USA/Canada  
**Email:** [orderlit@onsemi.com](mailto:orderlit@onsemi.com)

**N. American Technical Support:** 800-282-9855 Toll Free  
USA/Canada

**Japan:** ON Semiconductor, Japan Customer Focus Center  
2-9-1 Kamimeguro, Meguro-ku, Tokyo, Japan 153-0051  
**Phone:** 81-3-5773-3850

**ON Semiconductor Website:** <http://onsemi.com>

**Order Literature:** <http://www.onsemi.com/litorder>

For additional information, please contact your  
local Sales Representative.